

elevata affidabilità - high reliability

PANELLI®

italian excellence since 1906

6" 8" 10"

140 REC - 180 REC | 50Hz
230 REC

**POMPA SOMMERSA
SEMIASSIALE - GHISA
SEMIAXIAL SUBMERSIBLE
PUMP - CAST IRON**



MADE IN ITALY



6" - 8" - 10" REC - 1



6" 8" 10" 140 REC
 180 REC | **50Hz**
 230 REC

POMPA SOMMERSA SEMIASSIALE - GHISA
SEMIAXIAL SUBMERSIBLE PUMP - CAST IRON

Pompa semiassiale in ghisa: 6", 8" e 10"

6", 8" and 10" cast iron semi-axial pump

Pompe semi-axiale en fonte 6", 8" et 10"

Bomba semi-axial en hierro 6", 8" y 10"

Ampia gamma da 34 m³/ora a 240 m³/ora

Extensive range from 34 m³/hour up to 240 m³/hour

Gamme très complète de 34 m³/heure jusqu'à 240 m³/heure

Gama muy amplia de 34 m³/hora hasta 240 m³/hora

PANELLI®

italian excellence since 1906

Tolleranza alla sabbia 50 g/m³ - sand tolerance 50 g/m³
 Tolleranze secondo UNI ISO 9906 livello 3B - Tolerances according to UNI ISO 9906 grade 3B

6" - 8" - 10" REC - 2

elevata affidabilità - high reliability

PANELLI®

italian excellence since 1906

6" 8" 10" 140 REC 180 REC 230 REC | 50Hz

POMPA SOMMERSA SEMIASSIALE - GHISA
SEMIAXIAL SUBMERSIBLE PUMP - CAST IRON

Girante e diffusore in ghisa

Impeller and diffuser in cast iron

Roue et diffuseur en fonte

Rodete y difusor en hierro

Robustezza ineguagliabile

Heavy Duty construction

Durabilità

Durabilidad

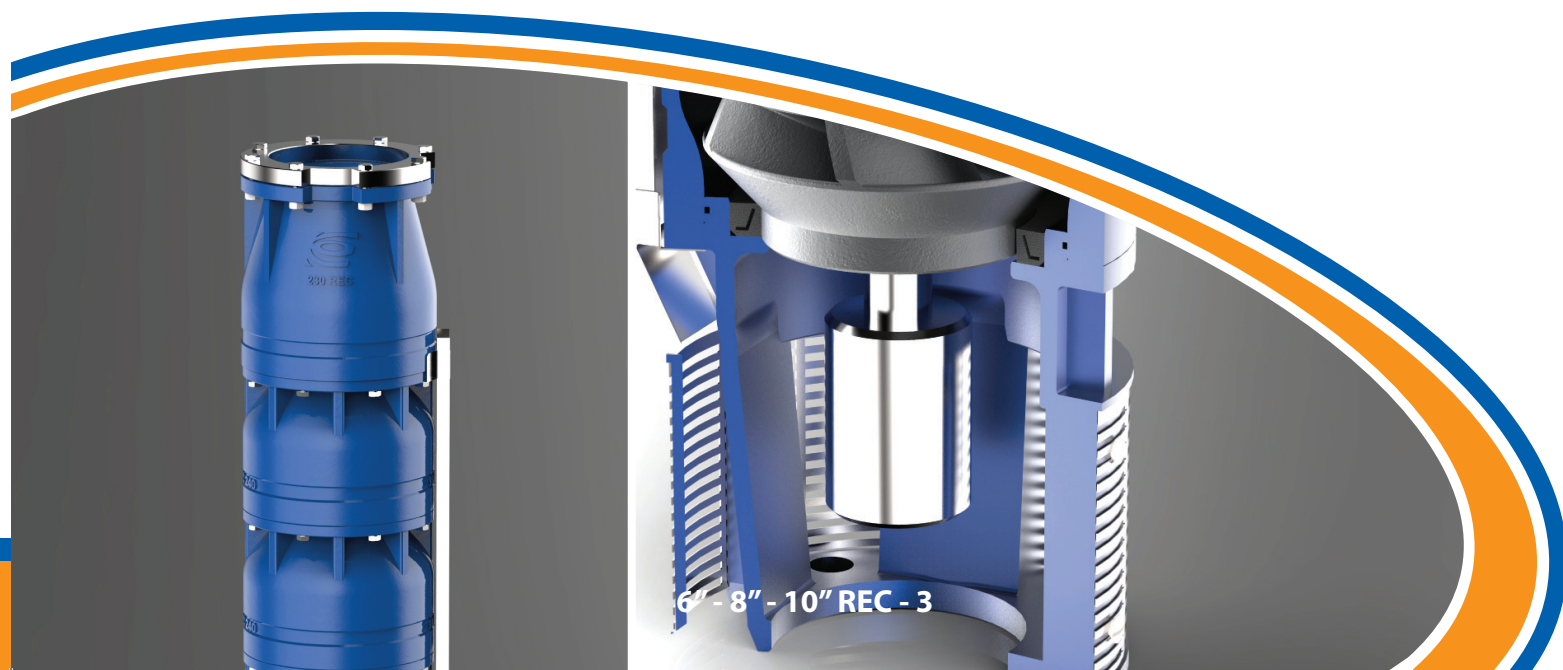



italian excellence since 1906

6" 8" 10" 140 REC
180 REC | 50Hz
230 REC

POMPA SOMMERSA SEMIASSIALE - GHISA
SEMIAXIAL SUBMERSIBLE PUMP - CAST IRON



ELETTROPOMPE SOMMERSE SEMIASSIALI 6"/8"/10"SERIE 140/180/230 REC, IN GHISA MECCANICA G25

Le pompe sommerse semiassiali sono caratterizzate da stadi formati dal corpo diffusore incorporato e girante semiassiale. Questo tipo di soluzione, rispetto a quella radiale, è ideale quando sono richieste a parità di diametro, medio-alte portate, con medie prevalenze. Adatte a sollevamento di acqua pulita, per approvvigionamento idrico ad uso civile ed industriale, impianti di pressurizzazione, antincendio ed irrigazione, acquedotti.

VANTAGGI

- rendimenti elevati
- facilità di smontaggio
- ridotta manutenzione
- bassi costi di esercizio

MATERIALI

- Girante, diffusore, gabbia di aspirazione e corpo valvola in ghisa meccanica G25 - Albero pompa in acciaio inox Aisi 304
- Anelli di usura, bronzine, guarnizione valvola in gomma NBR
- Anello di contropinta in PTFE+25% GRAFITE

CAMPI DI PRESTAZIONE IDRAULICHE

- Portate fino a 300 m³/h
- Prevalenze fino a 450 metri
- Potenze fino a 147 Kw
- Massima quantità di sabbia ammessa : 50 g/m³
- Massima profondità di immersione : 300 metri.



6"/8"/10"SUBMERSIBLE SEMIAXIAL PUMPS SERIES 140/180/230 REC, IN CAST IRON

The semi-axial pumps impellers with diffusers integrated. These pumps are usually ideal for medium-high capacity and medium head required. PANELLI production offer standard semi-axial pumps from 6" to 10".

ADVANTAGES

Panelli innovative design and the most advanced micro casting technologies allow:

- High efficiency
- Longer life
- Easy assembly/disassembly
- Low maintenance
- Low operating cost

MATERIALS

- Impellers, diffusers, suction cage and delivery bowl in cast iron
- Pump shaft in AISI 304 stainless steel
- Wear rings, bearing buses, valve seal in NBR
- Counter thrust in PTFE+25% GRAFITE

HYDRAULIC PERFORMANCES

- Capacity up to 300 m³/h
- Head up to 450 m
- Power up to 147 kW
- Maximum sand tolerance : 50g/m³
- Maximum depth : 300 metres up to 200 HP (147 Kw)

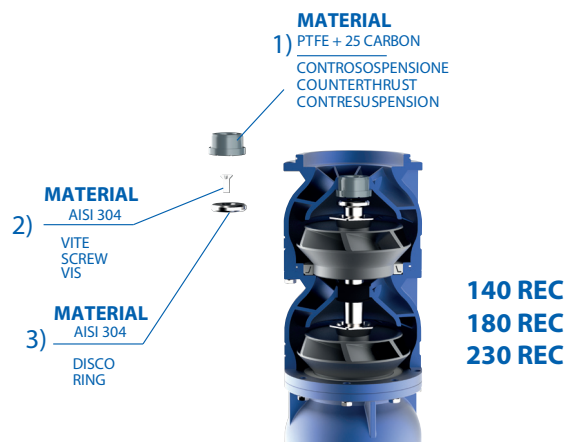

Tolleranza alla sabbia 50 g/m³ - sand tolerance 50 g/m³
Tolleranze secondo UNI ISO 9906 livello 3B - Tolerances according to UNI ISO 9906 grade 3B



italian excellence since 1906

6" 8" 10" 140 REC
180 REC | 50Hz
230 REC

POMPA SOMMERSA SEMIASSIALE - GHISA SEMIAxIAL SUBMERSIBLE PUMP - CAST IRON



POMPES IMMERGÉES SEMIAxIALES 6"/8"/10"SERIE 140/180/230 REC, EN FONTE

Les pompes immergées semiaxiales grâce au design des roues et des diffuseurs peuvent produire des débit moyens élevés et des hauteurs moyennes.

Les pompes sont conçues pour des eaux claires dans toutes applications domestiques, industrielles, systèmes de surpression, groupe incendie, irrigation et réseaux d'eau publiques.

ADVANTAGES

L'innovatif projet Panelli et les technologies de microfusion les plus modernes permettent d'obtenir:

- Très hautes efficiences
- Durée de vie importante
- Facilité de montage et démontage
- Manutention réduite
- Coûts d'exercice réduits

MATERIAUX

- Roues, diffuseurs, cage d'aspiration et refoulement en fonte
- Axe de la pompe en acier inoxydable AISI 304
- Bagues d'usure, bagues, anneau du clapet en caoutchouc NBR
- Contresuspension en PTFE+25% GRAFITE

PERFORMANCES HYDRAULIQUES

- Débit jusqu'à 300 m³/h
- Hauteur jusqu'à 450 m
- Puissance jusqu'à 147 kW
- Tolerance de sable maximum : 50 g/m³
- Profondité maximum d'immersion: 300 mètres



BOMBAS SUMERGIBLES SEMIAxIALES 6"/8"/10"SERIE 140/180/230 REC, EN HIERRO FUNDIDO

Las bombas sumergibles semiaxiales gracias al design de los impulsores y de los cuerpos se adaptan a caudales medio-elevados y alturas media. Concebidas para el bombeo de aguas limpias en aplicaciones civiles e industriales para el suministro de agua a nivel domestico, industrial, en grupos de pression, sistemas contra incendio, riego y sistemas de agua publica.

VENTAJAS

El design innovativo Panelli y las tecnologias mas modernas garantizan:

- Eficiencias elevadas
- Durada de vida muy importante
- Facilidad de montaje y desmontaje - Manutencion minima
- Costos de utilizacion muy limitados

MATERIALES

- Impulsores, difusores, caja de aspiracion e impulsion en hierro fundido
- Eje de bomba en acero inoxidable AISI 304
- Anillos de usura, bozina yanillo valvula en goma NBR.

PRESTACIONES HIDRAULICAS

- Caudales hasta 300 m³/h, Alturas hasta 450 m, Potencia hasta 147 kW
- Cantida m³ de arena contenida en el agua: 50g/m³, Sumergencia m³: 300 metres

Tolleranza alla sabbia 50 g/m³ - sand tolerance 50 g/m³
Tolleranze secondo UNI ISO 9906 livello 3B - Tolerances according to UNI ISO 9906 grade 3B



elevata affidabilità - high reliability

6"

140 REC34

PANELLI®

CARATTERISTICHE IDRAULICHE - HYDRAULIC PERFORMANCES

Q= Portata - Capacity - Debit **50 Hz n= 2900 min**

Tipo Type	Power		l/min	0	300	400	500	600	700	800	
	kW	HP		l/sec	0	5	6,67	8,33	10	11,67	13,33
				m ³ /h	0	18	24	30	36	42	48
140 REC 34/03	4	5,5	H(m)	43	36	33	30	27	22	15	
140 REC 34/04	5,5	7,5		57	48	44	40	37	30	20	
140 REC 34/05	7,5	10		71	60	55	50	46	37	25	
140 REC 34/06	7,5	10		86	72	66	60	55	45	30	
140 REC 34/07	9,2	12,5		100	84	77	70	64	52	35	
140 REC 34/08	11	15		114	96	88	80	73	59	40	
140 REC 34/09	11	15		129	108	99	90	82	67	45	
140 REC 34/10	13	17,5		143	120	110	100	91	74	50	
140 REC 34/11	13	17,5		157	132	121	110	101	82	55	
140 REC 34/12	15	20		171	144	132	120	110	89	60	
140 REC 34/13	15	20		186	156	143	130	119	97	65	
140 REC 34/14	18,5	25		200	168	154	140	128	104	70	
140 REC 34/15	18,5	25		214	180	165	150	137	111	75	

DIMENSIONI D'INGOMBRO E PESI - OVERALL DIMENSIONS AND WEIGHTS

Type	A mm Tri V 400	B mm	C mm Tri	M Kg Tri	P Kg
140 REC 34/03	1242	596	646	40	19
140 REC 34/04	1368	697	671	45	23
140 REC 34/05	1499	798	701	55	28
140 REC 34/06	1600	899	701	55	32
140 REC 34/07	1751	1000	751	60	36
140 REC 34/08	1912	1101	811	65	40
140 REC 34/09	2013	1202	811	65	44
140 REC 34/10	2144	1303	841	70	48
140 REC 34/11	2245	1404	841	70	52
140 REC 34/12	2436	1505	931	75	56
140 REC 34/13	2537	1606	931	75	60
140 REC 34/14	2698	1707	991	83	64
140 REC 34/15	2799	1808	991	83	69

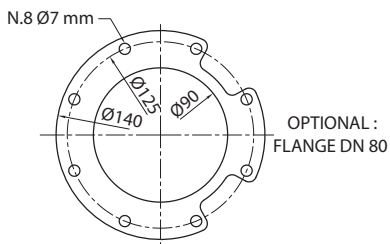
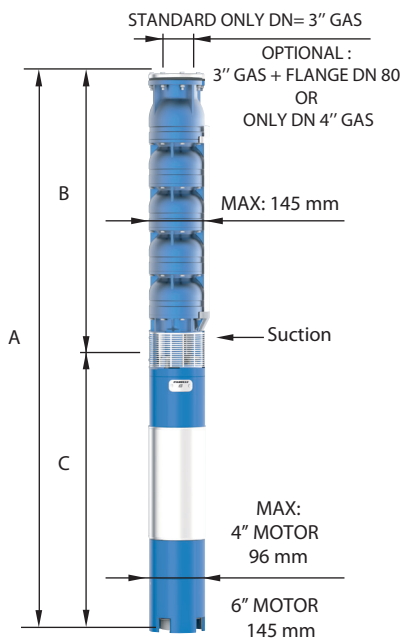

FOR COMMERCIAL TUBE
EXTERNAL DIAMETER: 88,9 mm

n% = Rendimento della pompa
n% = Rendement de la pompe
n% = Pump efficiency
n% = Rendimiento de la bomba

**Max
74%**

kW/st = Assorbimento per stadio
kW/st = Absorption par étage
kW/st = Stage absorption
kW/st = Potencia absorbida por etapa

**Max
1,22**

Tolleranza alla sabbia 50 g/m³ - Sand tolerance 50 g/m³
Tolleranze secondo UNI ISO 9906 livello 3B - Tolerances according to UNI ISO 9906 grade 3B

elevata affidabilità - high reliability

PANELLI®

6"

140 REC34

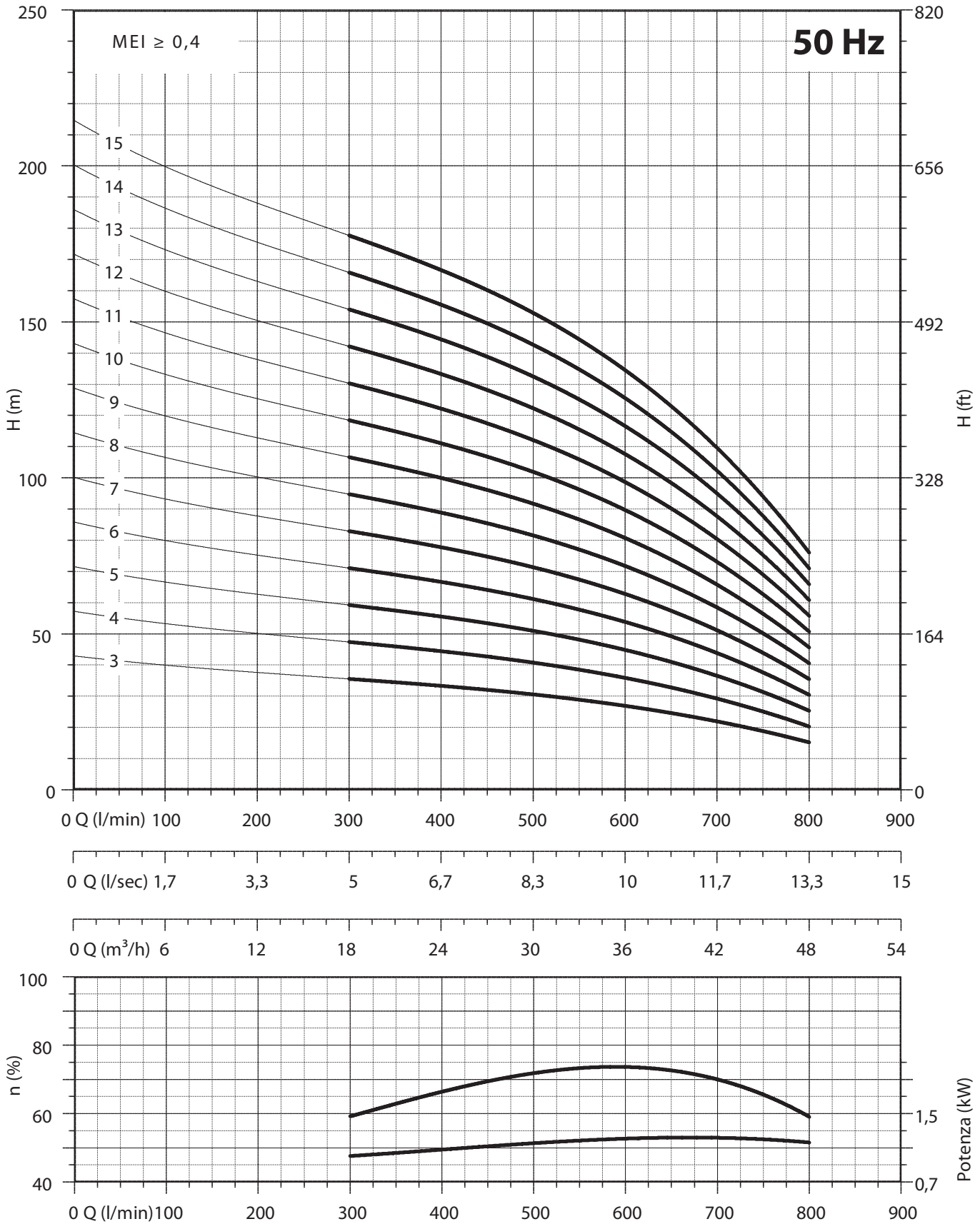

NPSH (m)	25%	50%	75%	100%
140 REC 34	3,4	3,4	3,8	8

elevata affidabilità - high reliability

6"

140 REC34

PANELLI®

CARATTERISTICHE IDRAULICHE - HYDRAULIC PERFORMANCES

Q= Portata - Capacity - Debit

50 Hz n= 2900 min

Tipo Type	Power		l/min	0	300	400	500	600	700	800	
	kW	HP		l/sec	0	5	6,67	8,33	10	11,67	13,33
				m³/h	0	18	24	30	36	42	48
140 REC 34/16	22	30	H(m)	229	192	176	160	146	119	80	
140 REC 34/17	22	30		243	204	187	170	155	126	85	
140 REC 34/18	22	30		257	216	198	180	165	134	90	
140 REC 34/19	26	35		271	228	209	190	174	141	95	
140 REC 34/20	26	35		286	240	220	200	183	149	100	
140 REC 34/21	26	35		300	252	231	210	192	156	105	
140 REC 34/22	26	35		314	264	242	220	201	163	110	
140 REC 34/23	30	40		329	276	253	230	210	171	115	
140 REC 34/24	30	40		343	288	264	240	219	178	120	
140 REC 34/25	30	40		357	300	275	250	229	186	125	
140 REC 34/26	37	50		371	312	286	260	238	193	130	
140 REC 34/27	37	50		386	324	297	270	247	201	135	
140 REC 34/28	37	50		400	336	308	280	256	208	140	
140 REC 34/29	37	50		414	348	319	290	265	215	145	
140 REC 34/30	37	50		429	360	330	300	274	223	150	

DIMENSIONI D'INGOMBRO E PESI - OVERALL DIMENSIONS AND WEIGHTS

Type	A mm Tri V 400	B mm	C mm Tri	M Kg Tri	P Kg
140 REC 34/16	2980	1909	1071	92	73
140 REC 34/17	3081	2010	1071	92	77
140 REC 34/18	3182	2111	1071	92	81
140 REC 34/19	3393	2212	1181	100	85
140 REC 34/20	3494	2313	1181	100	89
140 REC 34/21	3595	2414	1181	100	93
140 REC 34/22	3696	2515	1181	100	97
140 REC 34/23	3867	2616	1251	108	101
140 REC 34/24	3968	2717	1251	108	105
140 REC 34/25	4069	2818	1251	108	110
140 REC 34/26	4260	2919	1341	118	114
140 REC 34/27	4361	3020	1341	118	118
140 REC 34/28	4462	3121	1341	118	122
140 REC 34/29	4563	3222	1341	118	126
140 REC 34/30	4664	3323	1341	118	130

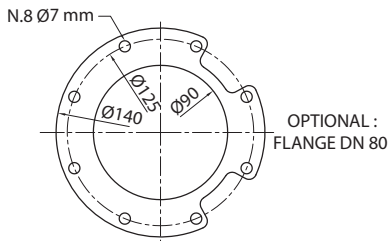
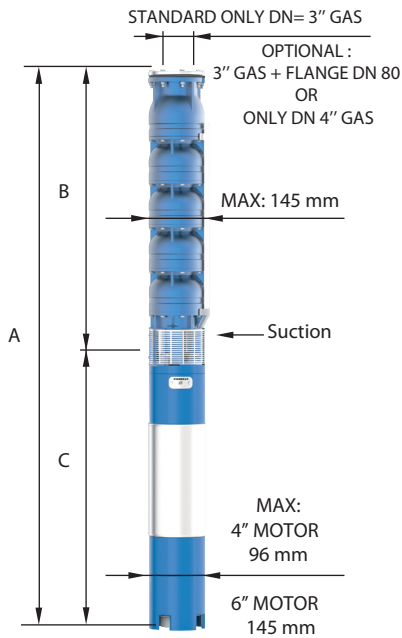

FOR COMMERCIAL TUBE
EXTERNAL DIAMETER: 88,9 mm

n% = Rendimento della pompa
n% = Rendement de la pompe
n% = Pump efficiency
n% = Rendimiento de la bomba

**Max
74%**

kW/st = Assorbimento per stadio
kW/st = Absorption par étage
kW/st = Stage absorption
kW/st = Potencia absorbida por etapa

**Max
1,22**

Tolleranza alla sabbia 50 g/m³ - Sand tolerance 50 g/m³
Tolleranze secondo UNI ISO 9906 livello 3B - Tolerances according to UNI ISO 9906 grade 3B

elevata affidabilità - high reliability

PANELLI®

6"

140 REC34

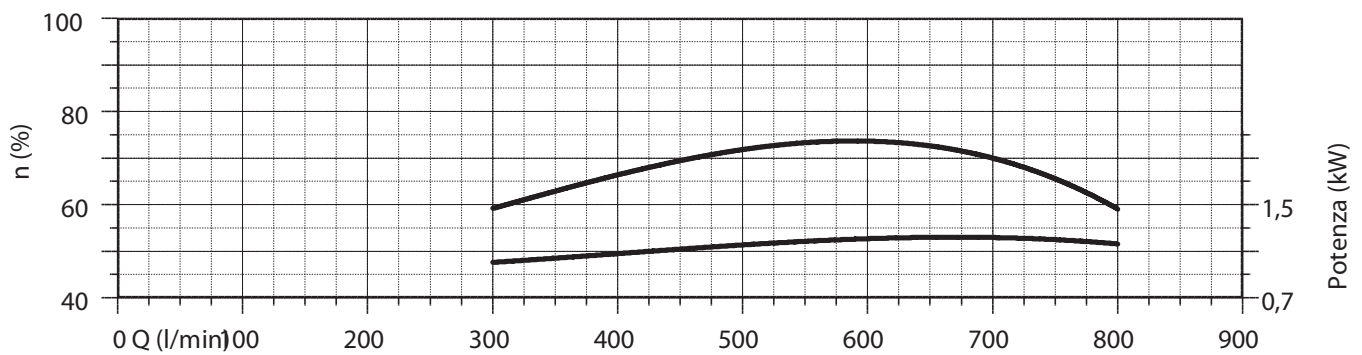
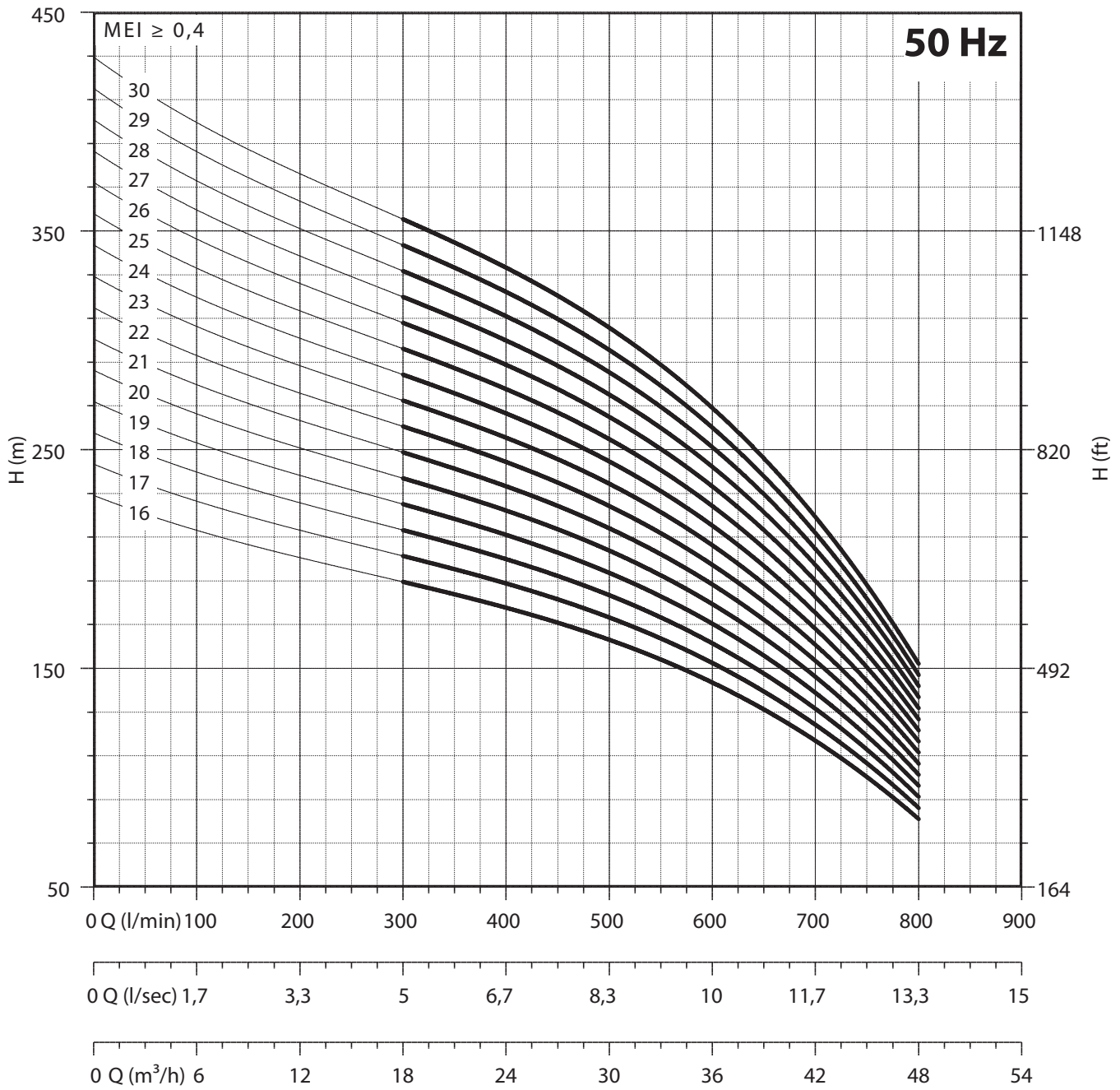

NPSH (m)	25%	50%	75%	100%
140 REC 34	3,4	3,4	3,8	8

elevata affidabilità - high reliability

6"

140 REC44

PANELLI®

CARATTERISTICHE IDRAULICHE - HYDRAULIC PERFORMANCES

Q= Portata - Capacity - Debit **50 Hz n= 2900 min**

Tipo Type	Power		H(m)	0	400	500	600	700	800	900	1000
	kW	HP		l/min	400	500	600	700	800	900	1000
				l/sec	6,67	8,33	10	11,67	13,33	15	16,67
140 REC 44/3	4	5,5		0	24	30	36	42	48	54	60
140 REC 44/4	5,5	7,5		40	32	31	29	26	22	17	10
140 REC 44/5	7,5	10		53	43	41	38	34	29	22	13
140 REC 44/6	9,2	12,5		67	53	51	48	43	36	28	17
140 REC 44/7	9,2	12,5		80	64	61	57	51	43	33	20
140 REC 44/8	11	15		93	75	71	67	60	50	39	23
140 REC 44/9	13	17,5		107	85	81	76	68	57	44	27
140 REC 44/10	13	17,5		120	96	92	86	77	65	50	30
140 REC 44/11	15	20		133	107	102	95	85	72	55	33
140 REC 44/12	15	20		147	117	112	105	94	79	61	37
140 REC 44/13	18,5	25		160	128	122	114	102	86	66	40
140 REC 44/14	18,5	25		173	139	132	124	111	93	72	43
140 REC 44/15	22	30		187	149	142	133	119	100	77	47
				200	160	153	143	128	108	83	50

DIMENSIONI D'INGOMBRO E PESI - OVERALL DIMENSIONS AND WEIGHTS

Type	A mm Tri V 400	B mm	C mm Tri	M Kg Tri	P Kg
140 REC 44/3	1242	596	646	40	19
140 REC 44/4	1368	697	671	45	23
140 REC 44/5	1499	798	701	55	28
140 REC 44/6	1650	899	751	60	32
140 REC 44/7	1751	1000	751	60	36
140 REC 44/8	1912	1101	811	65	40
140 REC 44/9	2043	1202	841	70	44
140 REC 44/10	2144	1303	841	70	48
140 REC 44/11	2335	1404	931	75	52
140 REC 44/12	2436	1505	931	75	56
140 REC 44/13	2597	1606	991	83	60
140 REC 44/14	2698	1707	991	83	64
140 REC 44/15	2879	1808	1071	92	69

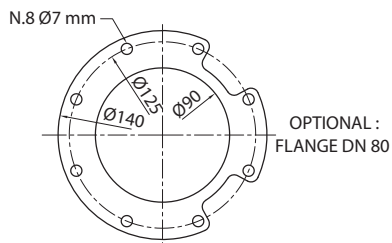
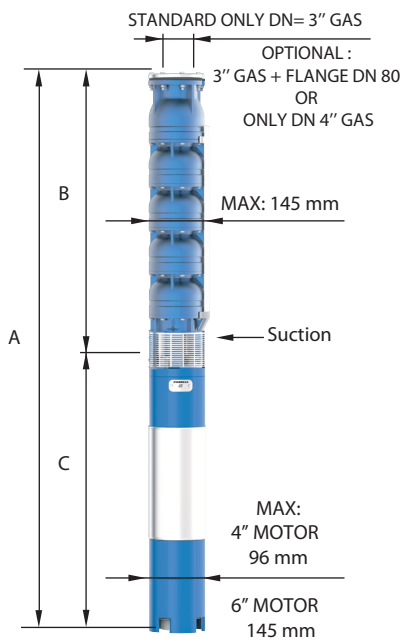

FOR COMMERCIAL TUBE
EXTERNAL DIAMETER: 88,9 mm

n% = Rendimento della pompa
n% = Rendement de la pompe
n% = Pump efficiency
n% = Rendimiento de la bomba

**Max
74%**

kW/st = Assorbimento per stadio
kW/st = Absorption par étage
kW/st = Stage absorption
kW/st = Potencia absorbida por etapa

**Max
1,32**

Tolleranza alla sabbia 50 g/m³ - Sand tolerance 50 g/m³
Tolleranze secondo UNI ISO 9906 livello 3B - Tolerances according to UNI ISO 9906 grade 3B

elevata affidabilità - high reliability

PANELLI®

6"

140 REC44

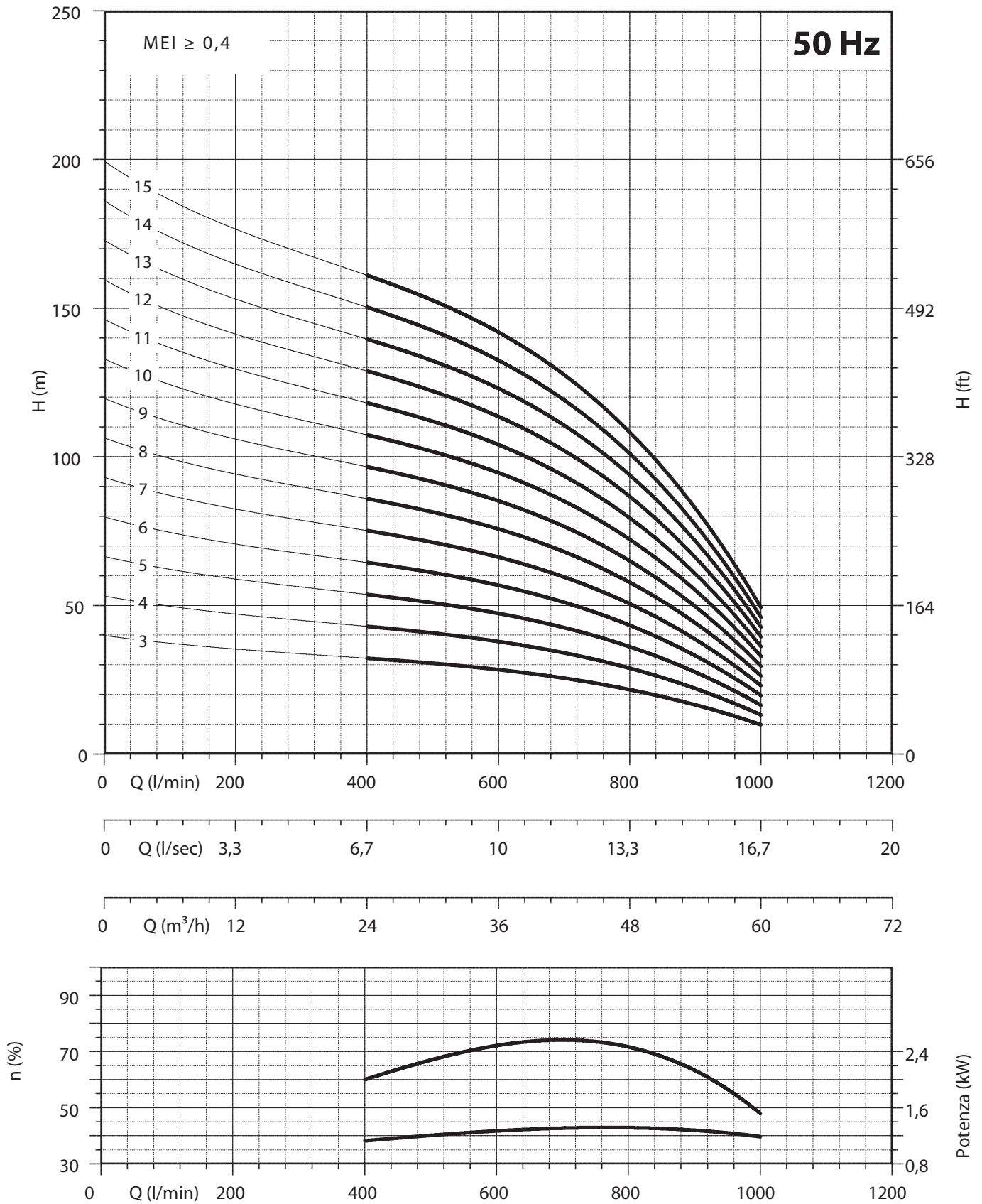

NPSH (m)	25%	50%	75%	100%
140 REC 44	3,45	3,5	3,8	5

elevata affidabilità - high reliability

6"

140 REC44

PANELLI®

CARATTERISTICHE IDRAULICHE - HYDRAULIC PERFORMANCES

Q= Portata - Capacity - Debit **50 Hz n= 2900 min**

Tipo Type	Power		H(m)	0	400	500	600	700	800	900	1000	
	kW	HP		l/min	l/sec	m ³ /h	l/min	l/sec	m ³ /h	l/min	l/sec	m ³ /h
				0	6,67	8,33	10	11,67	13,33	15	16,67	
140 REC 44/16	22	30		213	171	163	152	136	115	88	53	
140 REC 44/17	22	30		227	181	173	162	145	122	94	57	
140 REC 44/18	26	35		240	192	183	171	153	129	99	60	
140 REC 44/19	26	35		253	203	193	181	162	136	105	63	
140 REC 44/20	26	35		267	213	203	190	170	143	110	67	
140 REC 44/21	30	40		280	224	214	200	179	151	116	70	
140 REC 44/22	30	40		293	235	224	209	187	158	121	73	
140 REC 44/23	30	40		307	245	234	219	196	165	127	77	
140 REC 44/24	37	50		320	256	244	228	204	172	132	80	
140 REC 44/25	37	50		333	267	254	238	213	179	138	83	
140 REC 44/26	37	50		347	277	264	247	221	186	143	87	
140 REC 44/27	37	50		360	288	275	257	230	194	149	90	
140 REC 44/28	37	50		373	299	285	266	238	201	154	93	

DIMENSIONI D'INGOMBRO E PESI - OVERALL DIMENSIONS AND WEIGHTS

Type	A mm Tri V 400	B mm	C mm Tri	M Kg Tri	P Kg
140 REC 44/16	2980	1909	1071	92	73
140 REC 44/17	3081	2010	1071	92	77
140 REC 44/18	3292	2111	1181	100	81
140 REC 44/19	3393	2212	1181	100	85
140 REC 44/20	3494	2313	1181	100	89
140 REC 44/21	3665	2414	1251	108	93
140 REC 44/22	3766	2515	1251	108	97
140 REC 44/23	3867	2616	1251	108	101
140 REC 44/24	4058	2717	1341	118	105
140 REC 44/25	4159	2818	1341	118	110
140 REC 44/26	4260	2919	1341	118	114
140 REC 44/27	4361	3020	1341	118	118
140 REC 44/28	4462	3121	1341	118	122

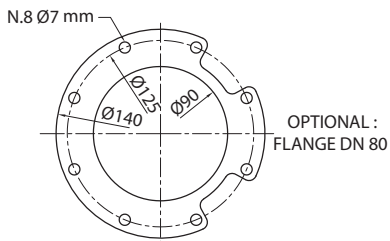
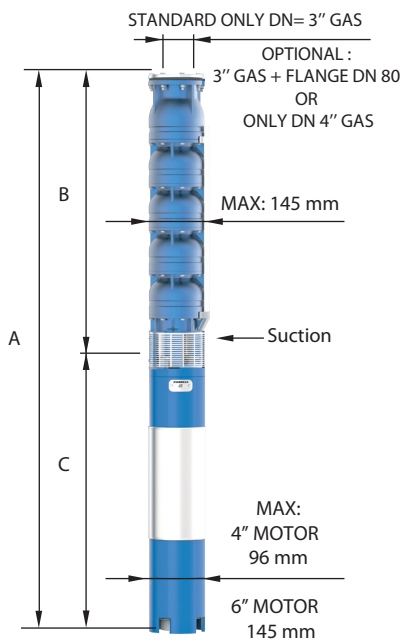

FOR COMMERCIAL TUBE
EXTERNAL DIAMETER: 88,9 mm

n% = Rendimento della pompa
n% = Rendement de la pompe
n% = Pump efficiency
n% = Rendimiento de la bomba

**Max
74%**

kW/st = Assorbimento per stadio
kW/st = Absorption par étage
kW/st = Stage absorption
kW/st = Potencia absorbida por etapa

**Max
1,32**

Tolleranza alla sabbia 50 g/m³ - Sand tolerance 50 g/m³
Tolleranze secondo UNI ISO 9906 livello 3B - Tolerances according to UNI ISO 9906 grade 3B

elevata affidabilità - high reliability

PANELLI®

6"

140 REC44

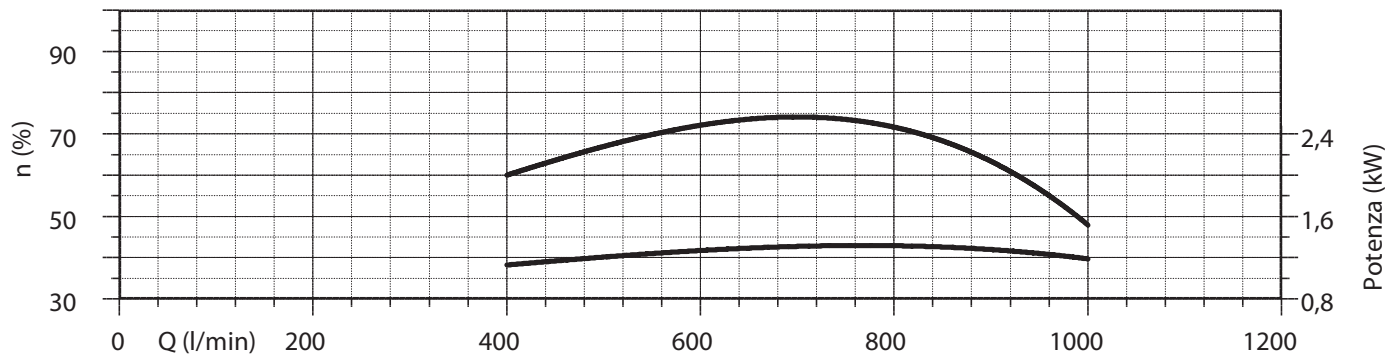
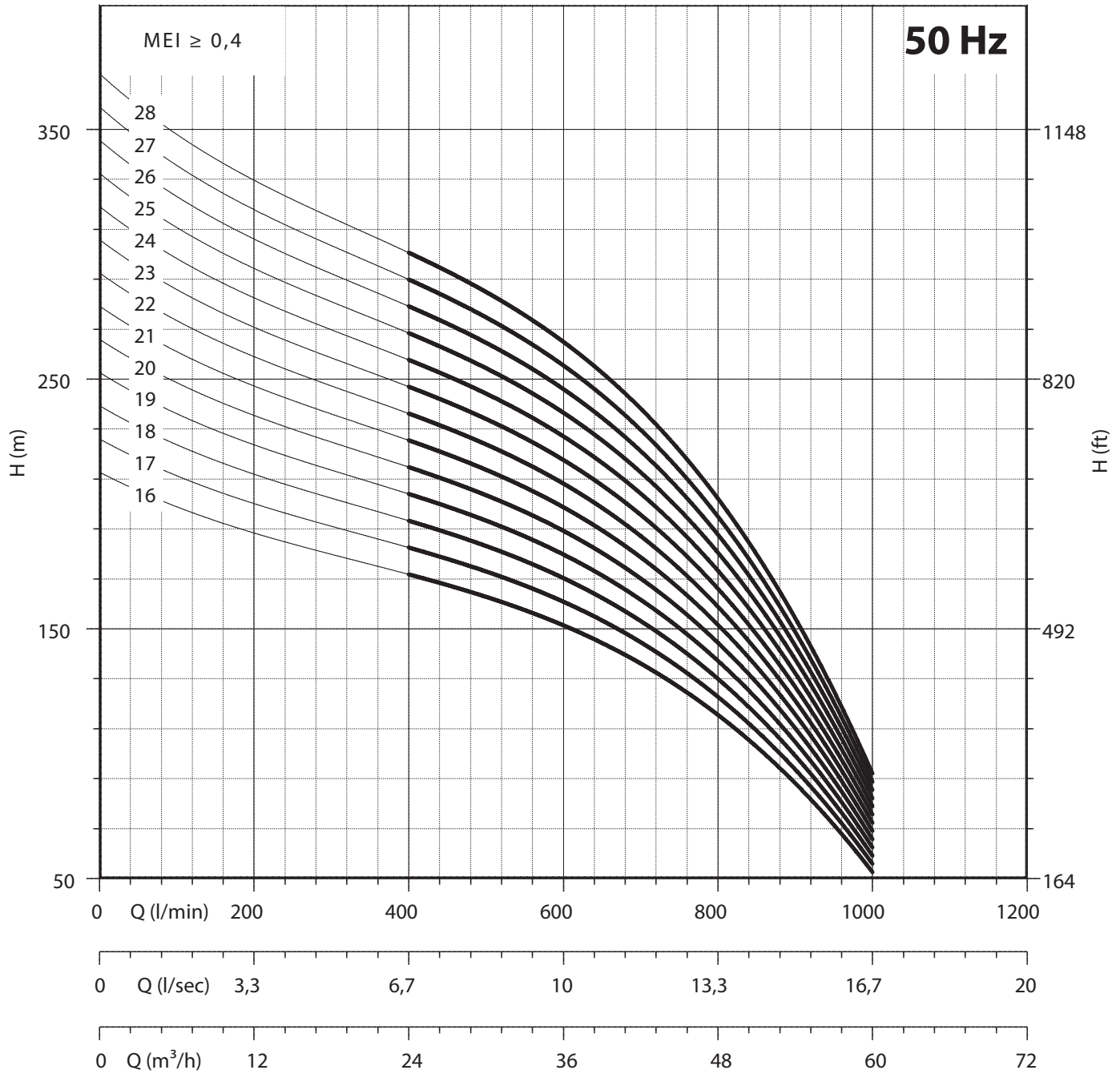

NPSH (m)	25%	50%	75%	100%
140 REC 44	3,45	3,5	3,8	5

elevata affidabilità - high reliability

6"

140 REC54

PANELLI®

CARATTERISTICHE IDRAULICHE - HYDRAULIC PERFORMANCES

Q= Portata - Capacity - Debit

50 Hz n= 2900 min

Tipo Type	Power		l/min	0	500	600	800	1000	1200
	kW	HP		l/sec	8,33	10	13,33	16,67	20
				m ³ /h	30	36	48	60	72
140 REC 54/3	5,5	7,5	H(m)	39	30	28	24	18	8
140 REC 54/4	7,5	10		52	40	38	32	24	10
140 REC 54/5	7,5	10		65	50	47	40	30	13
140 REC 54/6	9,2	12,5		78	60	56	48	35	16
140 REC 54/7	11	15		91	70	66	56	41	18
140 REC 54/8	13	17,5		104	80	75	64	47	21
140 REC 54/9	13	17,5		117	90	85	72	53	23
140 REC 54/10	15	20		130	100	94	80	59	26
140 REC 54/11	18,5	25		143	110	103	87	65	29
140 REC 54/12	18,5	25		156	120	113	95	71	31
140 REC 54/13	18,5	25		169	130	122	103	77	34
140 REC 54/14	22	30		182	140	132	111	83	36
140 REC 54/15	22	30		195	150	141	119	89	39
140 REC 54/16	26	35		208	160	150	127	94	42
140 REC 54/17	26	35		221	170	160	135	100	44
140 REC 54/18	26	35		234	180	169	143	106	47
140 REC 54/19	30	40		247	190	179	151	112	49
140 REC 54/20	30	40		260	200	188	159	118	52
140 REC 54/21	30	40		273	210	197	167	124	55
140 REC 54/22	37	50		286	220	207	175	130	57
140 REC 54/23	37	50		299	230	216	183	136	60
140 REC 54/24	37	50		312	240	226	191	142	62
140 REC 54/25	37	50		325	250	235	199	148	65

DIMENSIONI D'INGOMBRO E PESI - OVERALL DIMENSIONS AND WEIGHTS

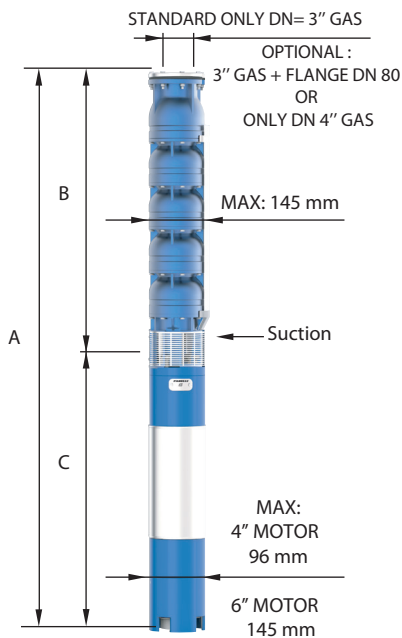

Type	A mm Tri V 400	B mm	C mm Tri	M Kg Tri	P Kg
140 REC 54/3	1285	614	671	45	21
140 REC 54/4	1422	721	701	55	25
140 REC 54/5	1529	828	701	55	30
140 REC 54/6	1686	935	751	60	34
140 REC 54/7	1853	1042	811	65	39
140 REC 54/8	1990	1149	841	70	43
140 REC 54/9	2097	1256	841	70	48
140 REC 54/10	2294	1363	931	75	52
140 REC 54/11	2461	1470	991	83	57
140 REC 54/12	2568	1577	991	83	61
140 REC 54/13	2675	1684	991	83	66
140 REC 54/14	2862	1791	1071	92	70
140 REC 54/15	2969	1898	1071	92	75
140 REC 54/16	3186	2005	1181	100	79
140 REC 54/17	3293	2112	1181	100	84
140 REC 54/18	3400	2219	1181	100	88
140 REC 54/19	3577	2326	1251	108	93
140 REC 54/20	3684	2433	1251	108	97
140 REC 54/21	3791	2540	1251	108	102
140 REC 54/22	3988	2647	1341	118	106
140 REC 54/23	4095	2754	1341	118	111
140 REC 54/24	4202	2861	1341	118	115
140 REC 54/25	4309	2968	1341	118	120

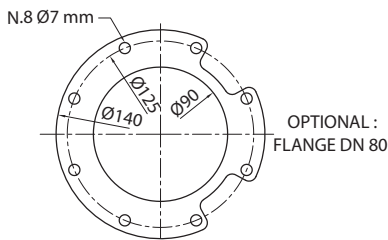

FOR COMMERCIAL TUBE
 EXTERNAL DIAMETER: 88,9 mm

n% = Rendimento della pompa
 n% = Rendement de la pompe
 n% = Pump efficiency
 n% = Rendimiento de la bomba

**Max
 73,6%**

kW/st = Assorbimento per stadio
 kW/st = Absorption par étage
 kW/st = Stage absorption
 kW/st = Potencia absorbida por etapa

**Max
 1,44**

Tolleranza alla sabbia 50 g/m³ - Sand tolerance 50 g/m³

Tolleranze secondo UNI ISO 9906 livello 3B - Tolerances according to UNI ISO 9906 grade 3B

elevata affidabilità - high reliability

PANELLI®

6"

140 REC54

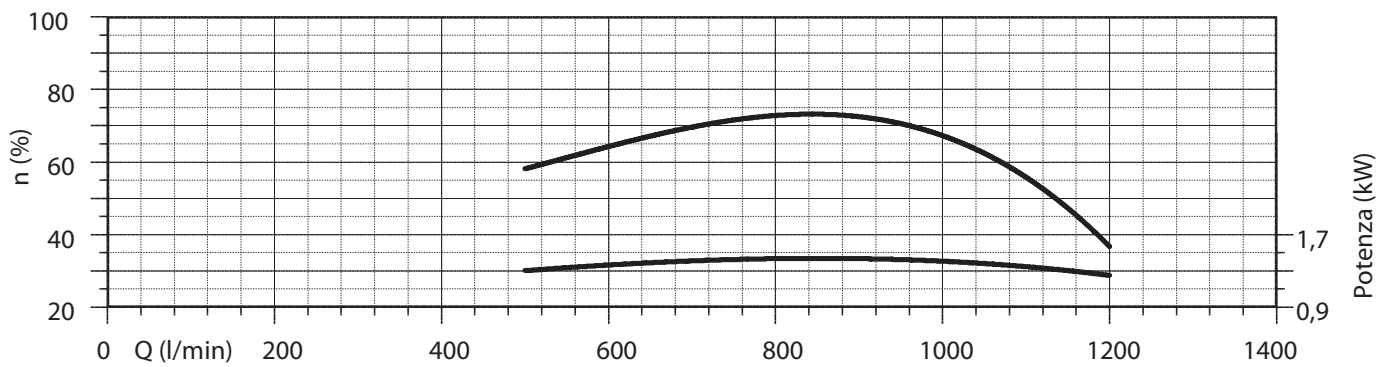
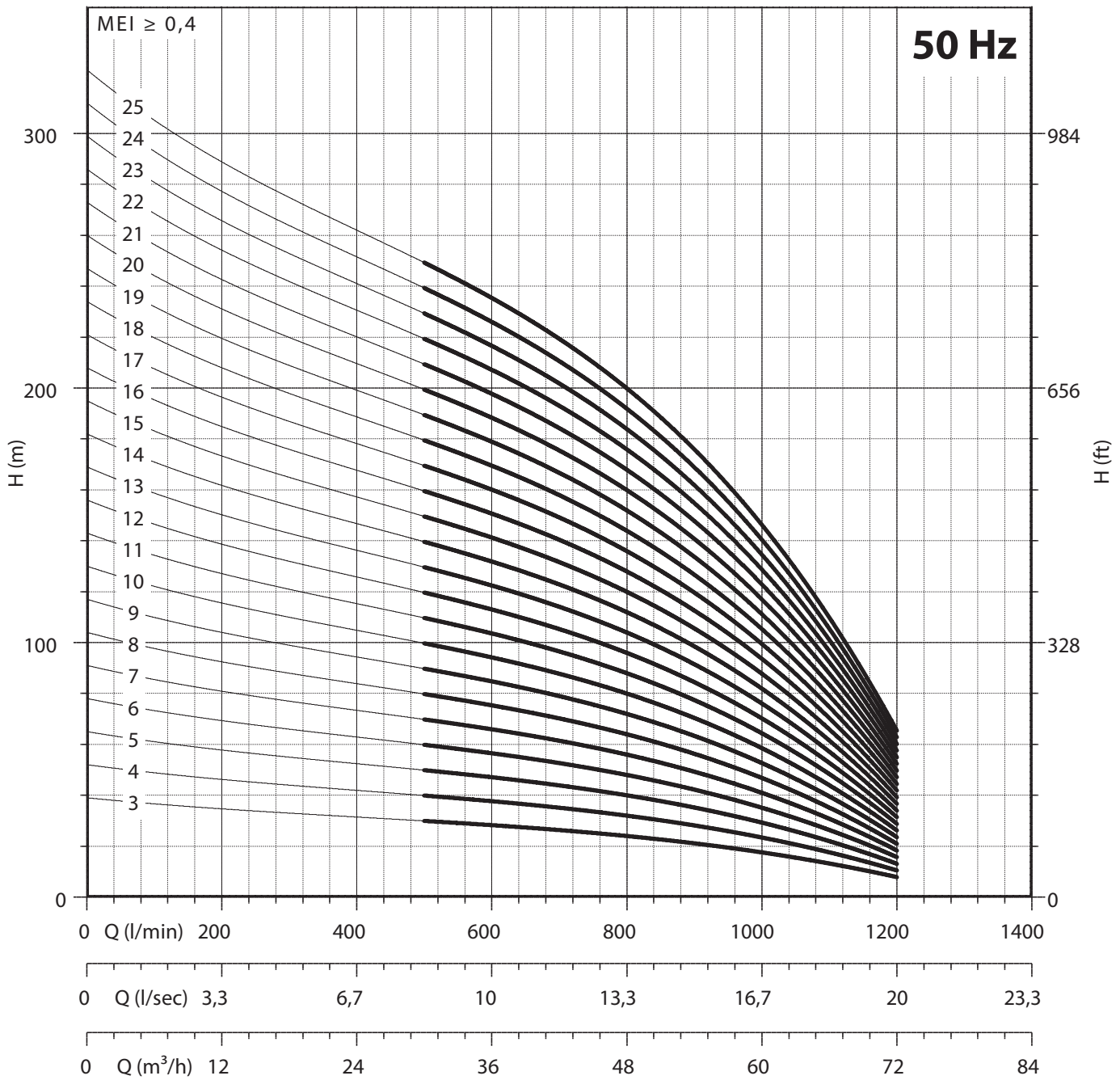

NPSH (m)	25%	50%	75%	100%
140 REC 54	3,8	3,8	5,1	7,1

6" - 8" - 10" REC - 15

elevata affidabilità - high reliability

6"

140 REC66

PANELLI®

CARATTERISTICHE IDRAULICHE - HYDRAULIC PERFORMANCES

Q= Portata - Capacity - Debit

50 Hz n= 2900 min

Tipo Type	Power		H(m)	0	600	800	1000	1200	1400
	kW	HP		l/min	l/sec	m ³ /h	l/min	l/sec	m ³ /h
				0	10	13,33	16,67	20	23,33
140 REC 66/3	5,5	7,5	39	29	26	23	17	6	
140 REC 66/4	7,5	10	52	39	35	31	23	8	
140 REC 66/5	9,2	12,5	65	49	44	39	29	10	
140 REC 66/6	11	15	78	59	53	47	34	12	
140 REC 66/7	13	17,5	91	69	62	55	40	14	
140 REC 66/8	15	20	104	78	70	62	46	16	
140 REC 66/9	15	20	117	88	79	70	51	18	
140 REC 66/10	18,5	25	130	98	88	78	57	20	
140 REC 66/11	22	30	143	108	97	86	63	22	
140 REC 66/12	22	30	156	118	106	94	68	24	
140 REC 66/13	22	30	169	127	114	101	74	26	
140 REC 66/14	26	35	182	137	123	109	80	28	
140 REC 66/15	26	35	195	147	132	117	86	30	
140 REC 66/16	30	40	208	157	141	125	91	32	
140 REC 66/17	30	40	221	167	150	133	97	34	
140 REC 66/18	37	50	234	176	158	140	103	36	
140 REC 66/19	37	50	247	186	167	148	108	38	
140 REC 66/20	37	50	260	196	176	156	114	40	
140 REC 66/21	37	50	273	206	185	164	120	42	

DIMENSIONI D'INGOMBRO E PESI - OVERALL DIMENSIONS AND WEIGHTS

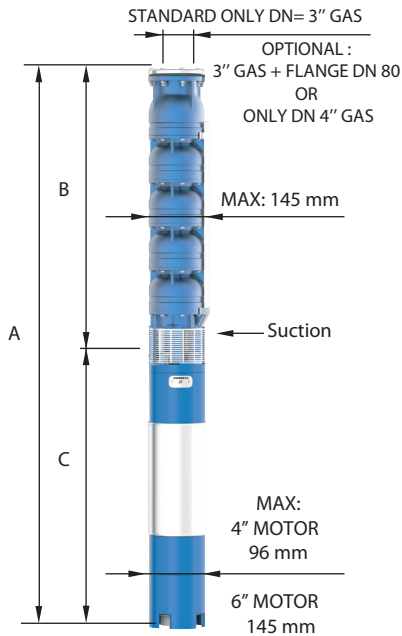

Type	A mm Tri V 400	B mm	C mm Tri	M Kg Tri	P Kg
140 REC 66/3	1285	614	671	45	21
140 REC 66/4	1422	721	701	55	25
140 REC 66/5	1579	828	751	60	30
140 REC 66/6	1746	935	811	65	34
140 REC 66/7	1883	1042	841	70	39
140 REC 66/8	2080	1149	931	75	43
140 REC 66/9	2187	1256	931	75	48
140 REC 66/10	2354	1363	991	83	52
140 REC 66/11	2541	1470	1071	92	57
140 REC 66/12	2648	1577	1071	92	61
140 REC 66/13	2755	1684	1071	92	66
140 REC 66/14	2972	1791	1181	100	70
140 REC 66/15	3079	1898	1181	100	75
140 REC 66/16	3256	2005	1251	108	79
140 REC 66/17	3363	2112	1251	108	84
140 REC 66/18	3560	2219	1341	118	88
140 REC 66/19	3667	2326	1341	118	93
140 REC 66/20	3774	2433	1341	118	97
140 REC 66/21	3881	2540	1341	118	102

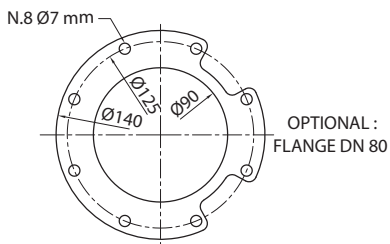

FOR COMMERCIAL TUBE
EXTERNAL DIAMETER: 88,9 mm

n% = Rendimento della pompa
n% = Rendement de la pompe
n% = Pump efficiency
n% = Rendimiento de la bomba

**Max
74%**

kW/st = Assorbimento per stadio
kW/st = Absorption par étage
kW/st = Stage absorption
kW/st = Potencia absorbida por etapa

**Max
1,74**

Tolleranza alla sabbia 50 g/m³ - Sand tolerance 50 g/m³
Tolleranze secondo UNI ISO 9906 livello 3B - Tolerances according to UNI ISO 9906 grade 3B

elevata affidabilità - high reliability

PANELLI®

6"

140 REC66

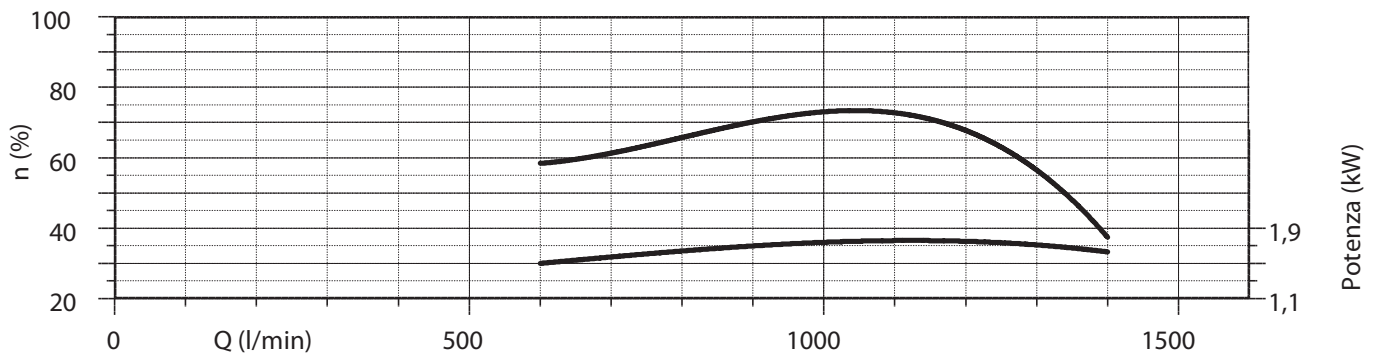
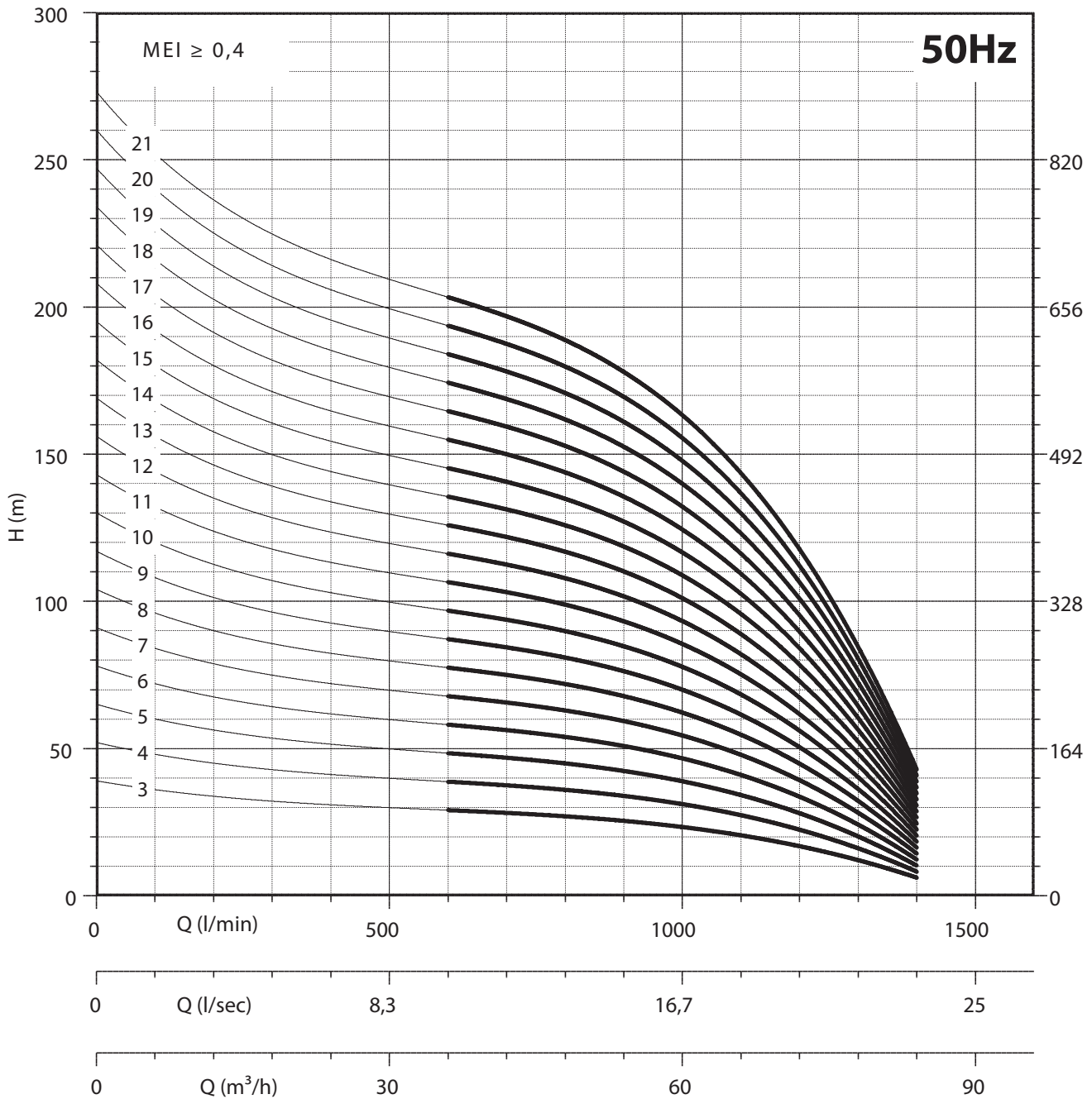

NPSH (m)	25%	50%	75%	100%
140 REC 66	3,8	3,8	5,1	7,1

elevata affidabilità - high reliability

8"

180 REC78

PANELLI®

CARATTERISTICHE IDRAULICHE - HYDRAULIC PERFORMANCES

Q= Portata - Capacity - Debit **50 Hz n= 2900 min**

Tipo Type	Power		l/min	0	600	800	1000	1200	1400	1600	
	kW	HP		l/sec	0	10	13,33	16,67	20	23,33	26,67
				m³/h	0	36	48	60	72	84	96
180 REC 78/1	5,5	7,5	H(m)	26	22	21	19	18	15	11	
180 REC 78/2	11	15		53	45	42	39	35	30	23	
180 REC 78/3	15	20		79	67	63	58	53	44	34	
180 REC 78/4	22	30		105	89	84	78	70	59	45	
180 REC 78/5	26	35		131	111	105	97	88	74	56	
180 REC 78/6	30	40		158	134	126	116	105	89	68	
180 REC 78/7	37	50		184	156	147	136	123	103	79	
180 REC 78/8	44	60		210	178	168	155	140	118	90	
180 REC 78/9	44	60		236	200	189	174	158	133	101	
180 REC 78/10	55	75		263	223	210	194	175	148	113	
180 REC 78/11	55	75		289	245	231	213	193	162	124	
180 REC 78/12	66	90		315	267	252	233	210	177	135	
180 REC 78/13	66	90		341	289	273	252	228	192	146	
180 REC 78/14	75	100		368	312	294	271	245	207	158	
180 REC 78/15	75	100		394	334	315	291	263	221	169	

DIMENSIONI D'INGOMBRO E PESI - OVERALL DIMENSIONS AND WEIGHTS

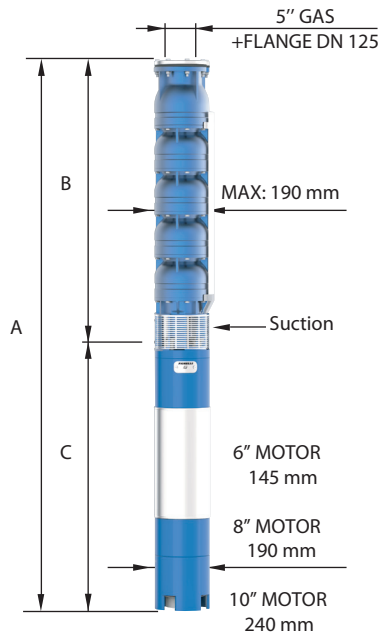

Type	A mm Tri V 400	B mm	C mm Tri	M Kg Tri	P Kg
180 REC 78/1	1225	527	671	45	23
180 REC 78/2	1463	652	811	65	31
180 REC 78/3	1708	777	931	75	39
180 REC 78/4	1973	902	1071	92	48
180 REC 78/5	2208	1027	1181	100	56
180 REC 78/6	2403	1152	1251	108	64
180 REC 78/7	2618	1277	1341	118	73
180 REC 78/8	2525	1402	1123	178	81
180 REC 78/9	2650	1527	1123	178	89
180 REC 78/10	2885	1652	1233	200	98
180 REC 78/11	3010	1777	1233	200	106
180 REC 78/12	3205	1902	1303	214	114
180 REC 78/13	3330	2027	1303	214	122
180 REC 78/14	3535	2152	1383	230	131
180 REC 78/15	3660	2277	1383	230	139

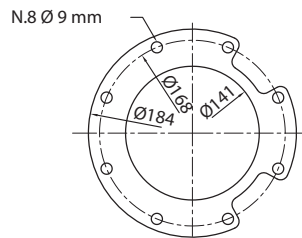

FOR COMMERCIAL TUBE
EXTERNAL DIAMETER: 139,7 mm

n% = Rendimento della pompa
n% = Rendement de la pompe
n% = Pump efficiency
n% = Rendimiento de la bomba

**Max
70%**

kW/st = Assorbimento per stadio
kW/st = Absorption par étage
kW/st = Stage absorption
kW/st = Potencia absorbida por etapa

**Max
5,1**

Tolleranza alla sabbia 50 g/m³ - Sand tolerance 50 g/m³
Tolleranze secondo UNI ISO 9906 livello 3B - Tolerances according to UNI ISO 9906 grade 3B

elevata affidabilità - high reliability

PANELLI®

8"

180 REC78

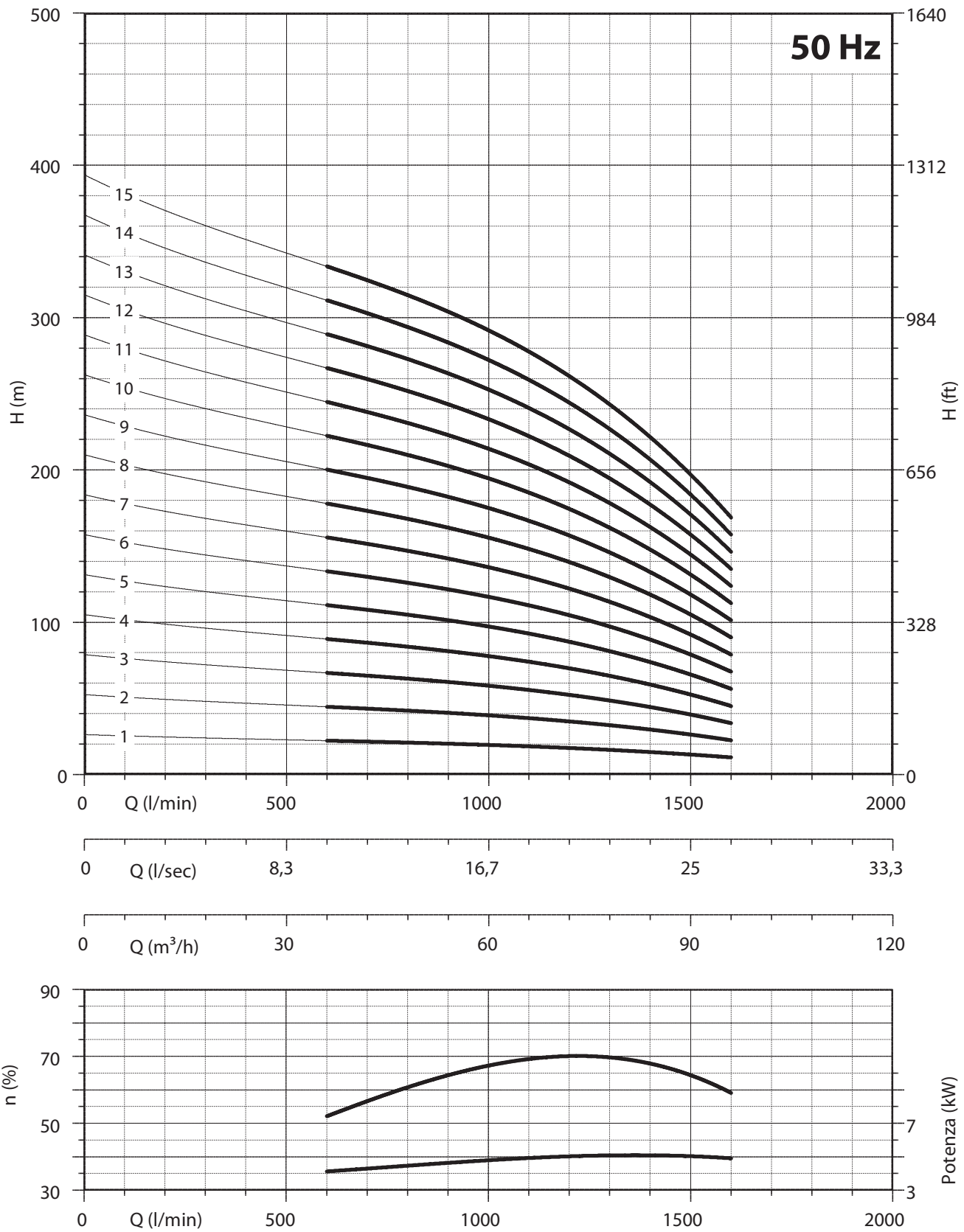

NPSH (m)	25%	50%	75%	100%
180 REC 78	3	3	3,5	4,5

elevata affidabilità - high reliability

8"

180 REC90

PANELLI®

CARATTERISTICHE IDRAULICHE - HYDRAULIC PERFORMANCES

Q= Portata - Capacity - Debit **50 Hz n= 2900 min**

Tipo Type	Power		l/min	0	800	1000	1200	1400	1600	1800	2000	
	kW	HP		l/sec	0	13,33	16,67	20	23,33	26,67	30	33,33
				m ³ /h	0	48	60	72	84	96	108	120
180 REC 90/1	7,5	10	H(m)	26	22	21	20	18	15	13	10	
180 REC 90/2	13	17,5		53	44	42	39	35	31	25	20	
180 REC 90/3	18,5	25		79	66	63	59	53	46	38	29	
180 REC 90/4	26	35		105	89	84	78	70	61	50	39	
180 REC 90/5	30	40		131	111	104	98	88	76	63	49	
180 REC 90/6	37	50		158	133	125	117	105	92	75	59	
180 REC 90/7	44	60		184	155	146	137	123	107	88	68	
180 REC 90/8	55	75		210	177	167	156	140	122	100	78	
180 REC 90/9	55	75		236	199	188	176	158	137	113	88	
180 REC 90/10	66	90		263	221	209	195	175	153	125	98	
180 REC 90/11	66	90		289	243	230	215	193	168	138	107	
180 REC 90/12	75	100		315	266	251	234	210	183	150	117	
180 REC 90/13	75	100		341	288	271	254	228	198	163	127	
180 REC 90/14	92	125		368	310	292	273	245	214	175	137	
180 REC 90/15	92	125		394	332	313	293	263	229	188	146	

DIMENSIONI D'INGOMBRO E PESI - OVERALL DIMENSIONS AND WEIGHTS

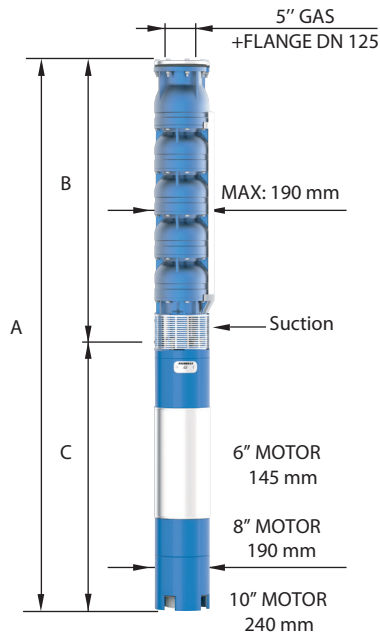

Type	A mm Tri V 400	B mm	C mm Tri	M Kg Tri	P Kg
180 REC 90/1	1228	527	701	55	23
180 REC 90/2	1493	652	841	70	31
180 REC 90/3	1768	777	991	83	39
180 REC 90/4	2083	902	1181	100	48
180 REC 90/5	2278	1027	1251	108	56
180 REC 90/6	2493	1152	1341	118	64
180 REC 90/7	2400	1277	1123	178	73
180 REC 90/8	2635	1402	1233	200	81
180 REC 90/9	2760	1527	1233	200	89
180 REC 90/10	2955	1652	1303	214	98
180 REC 90/11	3080	1777	1303	214	106
180 REC 90/12	3285	1902	1383	230	114
180 REC 90/13	3410	2027	1383	230	122
180 REC 90/14	3735	2152	1583	270	131
180 REC 90/15	3860	2277	1583	270	139

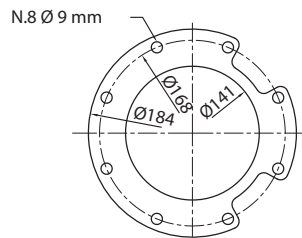

FOR COMMERCIAL TUBE
EXTERNAL DIAMETER: 139,7 mm

n% = Rendimento della pompa
n% = Rendement de la pompe
n% = Pump efficiency
n% = Rendimiento de la bomba

**Max
70%**

kW/st = Assorbimento per stadio
kW/st = Absorption par étage
kW/st = Stage absorption
kW/st = Potencia absorbida por etapa

**Max
5,9**

Tolleranza alla sabbia 50 g/m³ - Sand tolerance 50 g/m³
Tolleranze secondo UNI ISO 9906 livello 3B - Tolerances according to UNI ISO 9906 grade 3B

6" - 8" - 10" REC - 20

elevata affidabilità - high reliability

PANELLI®

8"

180 REC90

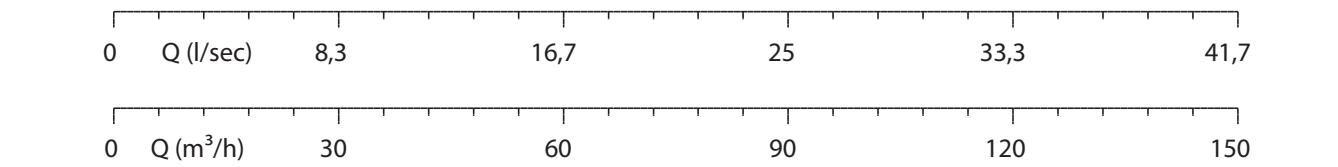
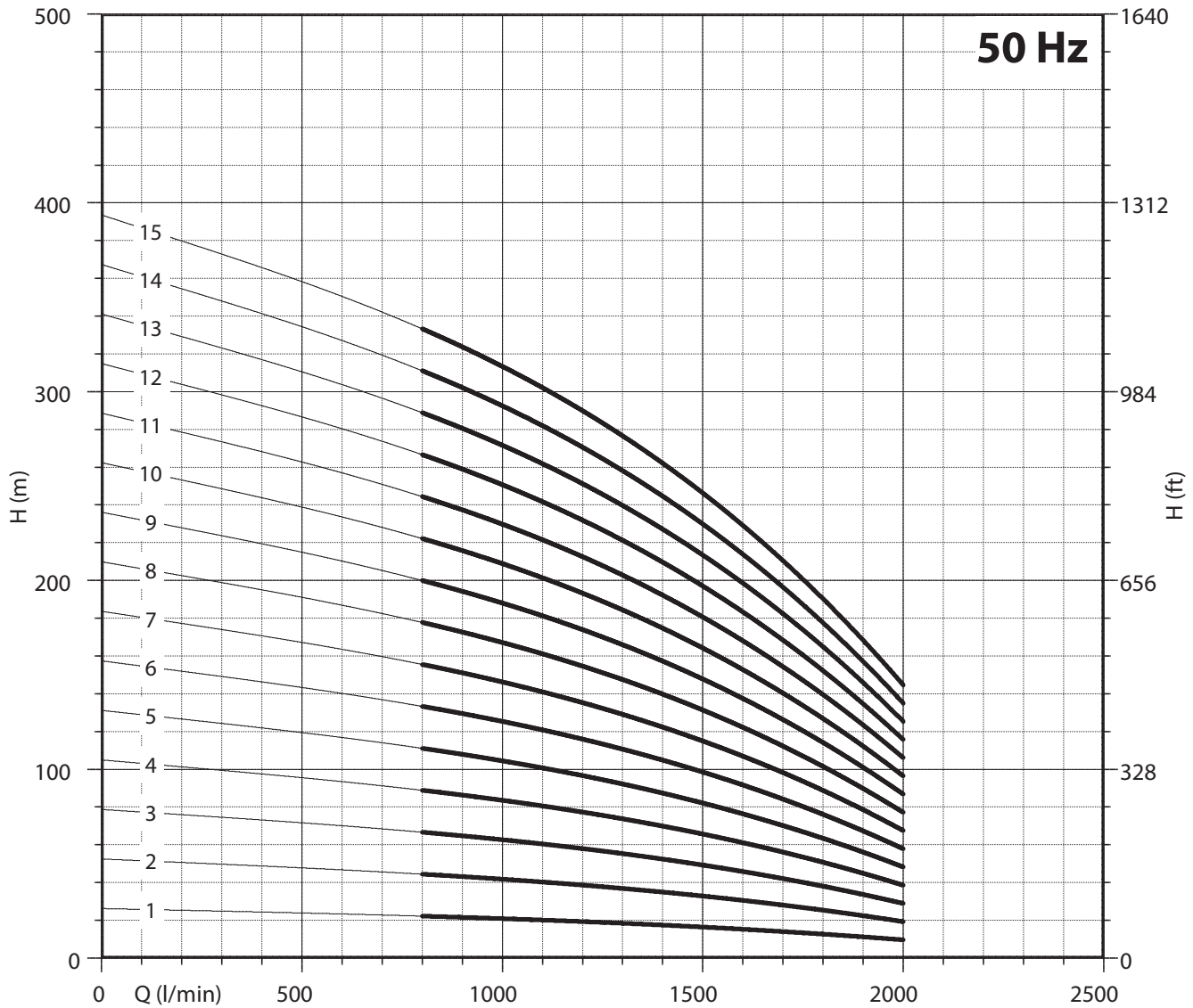

NPSH (m)	25%	50%	75%	100%
180 REC 90	3	4	5	8

elevata affidabilità - high reliability

8"

180 REC102

PANELLI®

CARATTERISTICHE IDRAULICHE - HYDRAULIC PERFORMANCES

Q= Portata - Capacity - Debit **50 Hz n= 2900 min**

Tipo Type	Power		H(m)	0	1000	1200	1400	1600	1800	2000	2200	2400			
	kW	HP		l/min	l/sec	m ³ /h	0	16,67	20	23,33	26,67	30	33,33	36,67	40
				0	60	72	84	96	108	120	132	144			
180 REC 102/1	7,5	10		26	22	21	20	19	18	16	14	11			
180 REC 102/2	15	20		53	44	42	40	38	35	32	28	22			
180 REC 102/3	22	30		79	66	63	60	57	53	48	42	33			
180 REC 102/4	30	40		105	87	84	80	76	71	65	55	45			
180 REC 102/5	37	50		131	109	105	100	95	89	81	69	56			
180 REC 102/6	44	60		158	131	126	120	114	106	97	83	67			
180 REC 102/7	55	75		184	153	147	140	133	124	113	97	78			
180 REC 102/8	66	90		210	175	168	160	152	142	129	111	89			
180 REC 102/9	66	90		237	197	189	180	171	159	145	125	100			
180 REC 102/10	75	100		263	219	210	200	190	177	161	139	111			
180 REC 102/11	92	125		289	240	231	220	209	195	178	152	123			
180 REC 102/12	92	125		315	262	252	240	228	213	194	166	134			
180 REC 102/13	92	125		342	284	273	260	247	230	210	180	145			

DIMENSIONI D'INGOMBRO E PESI - OVERALL DIMENSIONS AND WEIGHTS

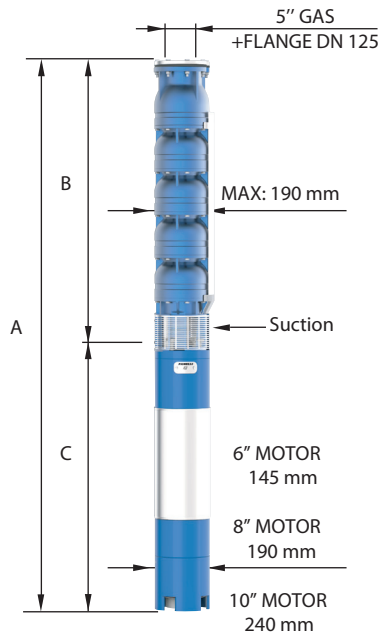

Type	A mm Tri V 400	B mm	C mm Tri	M Kg Tri	P Kg
180 REC 102/1	1228	527	701	55	23
180 REC 102/2	1583	652	931	75	32
180 REC 102/3	1848	777	1071	92	40
180 REC 102/4	2153	902	1251	108	49
180 REC 102/5	2368	1027	1341	118	58
180 REC 102/6	2275	1152	1123	178	66
180 REC 102/7	2510	1277	1233	200	75
180 REC 102/8	2705	1402	1303	214	83
180 REC 102/9	2830	1527	1303	214	92
180 REC 102/10	3035	1652	1383	230	101
180 REC 102/11	3360	1777	1583	270	109
180 REC 102/12	3485	1902	1583	270	118
180 REC 102/13	3610	2027	1583	270	126

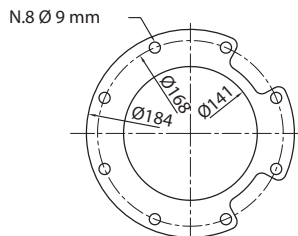

FOR COMMERCIAL TUBE
EXTERNAL DIAMETER: 139,7 mm

n% = Rendimento della pompa
n% = Rendement de la pompe
n% = Pump efficiency
n% = Rendimiento de la bomba

**Max
74%**

kW/st = Assorbimento per stadio
kW/st = Absorption par étage
kW/st = Stage absorption
kW/st = Potencia absorbida por etapa

**Max
7,3**

Tolleranza alla sabbia 50 g/m³ - Sand tolerance 50 g/m³
Tolleranze secondo UNI ISO 9906 livello 3B - Tolerances according to UNI ISO 9906 grade 3B

elevata affidabilità - high reliability

PANELLI®

8"

180 REC102

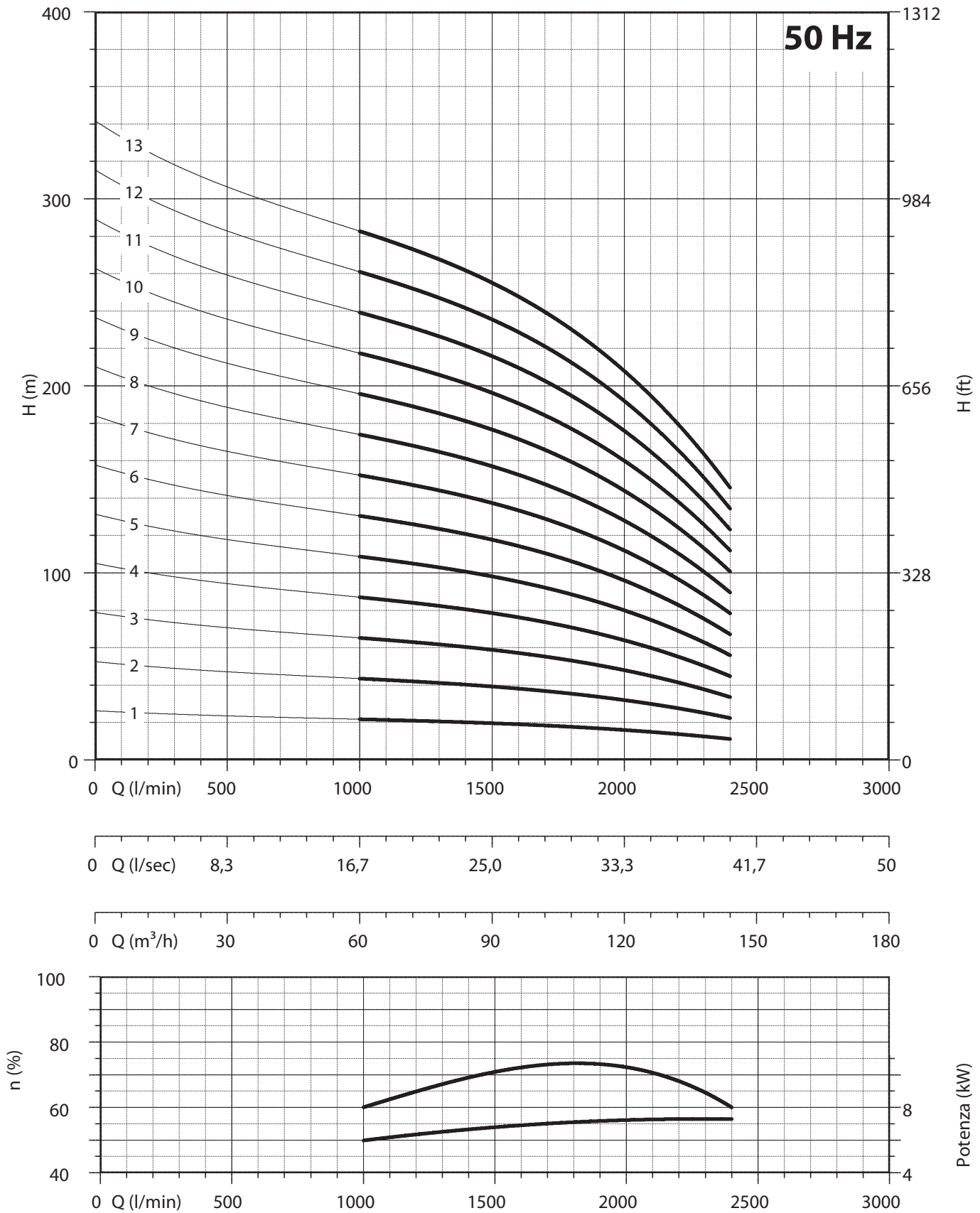

NPSH (m)	25%	50%	75%	100%
180 REC 102	2,5	3,5	4,5	8

elevata affidabilità - high reliability

8"

180 REC124

PANELLI®

CARATTERISTICHE IDRAULICHE - HYDRAULIC PERFORMANCES

Q= Portata - Capacity - Debit

50 Hz n= 2900 min

Tipo Type	Power		H(m)	0	1200	1400	1600	1800	2000	2200	2400	2600	2800		
	kW	HP		l/min	l/sec	m ³ /h	l/min	l/sec	m ³ /h	l/min	l/sec	m ³ /h	l/min	l/sec	m ³ /h
				0	20	23,33	26,67	30	33,33	36,67	40	43,33	46,67		
180 REC 124/1	7,5	10	26	21	20	19	18	17	15	13	11	8			
180 REC 124/2	15	20	53	42	41	38	36	34	31	27	21	15			
180 REC 124/3	26	35	79	63	61	57	54	51	46	40	32	23			
180 REC 124/4	30	40	106	85	81	77	73	67	62	54	43	30			
180 REC 124/5	44	60	132	106	101	96	91	84	77	67	54	38			
180 REC 124/6	55	75	159	127	122	115	109	101	93	81	64	45			
180 REC 124/7	55	75	185	148	142	134	127	118	108	94	75	53			
180 REC 124/8	66	90	211	169	162	153	145	135	123	107	86	61			
180 REC 124/9	75	100	238	190	183	172	163	152	139	121	96	68			
180 REC 124/10	75	100	264	211	203	191	181	169	154	134	107	76			
180 REC 124/11	92	125	291	233	223	211	200	185	170	148	118	83			
180 REC 124/12	92	125	317	254	243	230	218	202	185	161	129	91			
180 REC 124/13	110	150	344	275	264	249	236	219	201	175	139	98			
180 REC 124/14	110	150	370	296	284	268	254	236	216	188	150	106			

DIMENSIONI D'INGOMBRO E PESI - OVERALL DIMENSIONS AND WEIGHTS

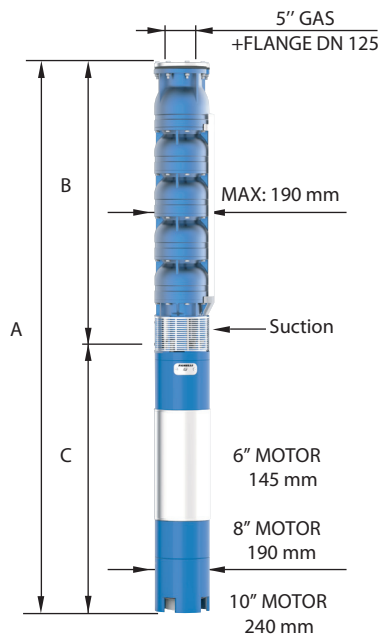

Type	A mm Tri V 400	B mm	C mm Tri	M Kg Tri	P Kg
180 REC 124/1	1228	527	701	55	23
180 REC 124/2	1583	652	931	75	32
180 REC 124/3	1958	777	1181	100	41
180 REC 124/4	2153	902	1251	108	49
180 REC 124/5	2150	1027	1123	178	58
180 REC 124/6	2385	1152	1233	200	67
180 REC 124/7	2510	1277	1233	200	75
180 REC 124/8	2705	1402	1303	214	84
180 REC 124/9	2910	1527	1383	230	93
180 REC 124/10	3035	1652	1383	230	102
180 REC 124/11	3360	1777	1583	270	110
180 REC 124/12	3485	1902	1583	270	119
180 REC 124/13	3760	2027	1733	300	128
180 REC 124/14	3885	2152	1733	300	136

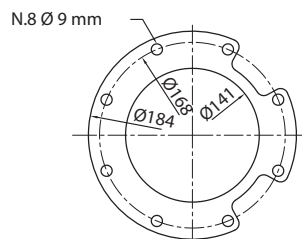

FOR COMMERCIAL TUBE
EXTERNAL DIAMETER: 139,7 mm

n% = Rendimento della pompa
n% = Rendement de la pompe
n% = Pump efficiency
n% = Rendimiento de la bomba

**Max
75%**

kW/st = Assorbimento per stadio
kW/st = Absorption par étage
kW/st = Stage absorption
kW/st = Potencia absorbida por etapa

**Max
7,7**

Tolleranza alla sabbia 50 g/m³ - Sand tolerance 50 g/m³
Tolleranze secondo UNI ISO 9906 livello 3B - Tolerances according to UNI ISO 9906 grade 3B

elevata affidabilità - high reliability

PANELLI®

8"

180 REC124

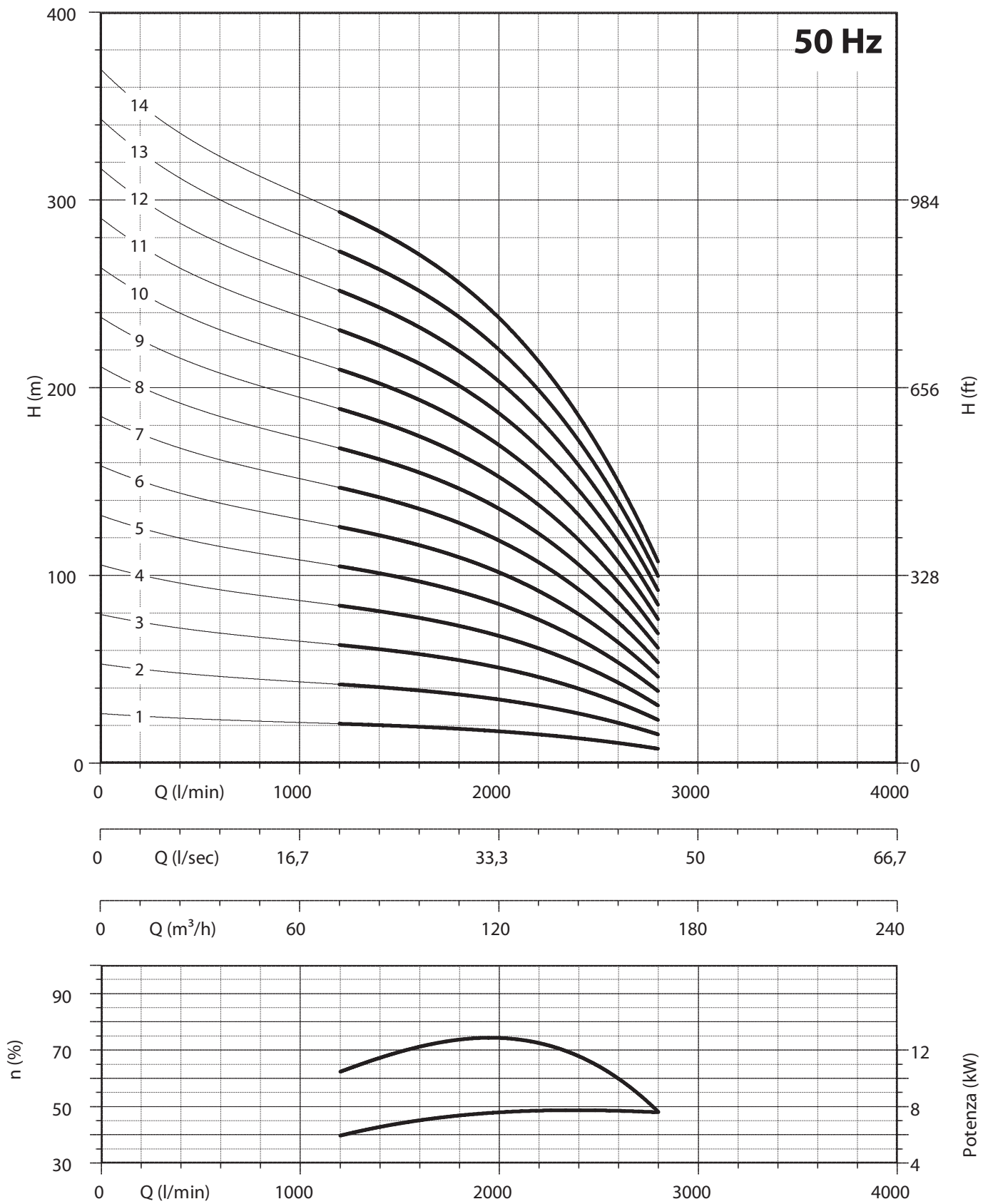

NPSH (m)	25%	50%	75%	100%
180 REC 124	2,5	3	5	9

6" - 8" - 10" REC - 25

elevata affidabilità - high reliability

8"

180 REC160

PANELLI®

CARATTERISTICHE IDRAULICHE - HYDRAULIC PERFORMANCES

Q= Portata - Capacity - Debit **50 Hz n= 2900 min**

Tipo Type	Power		H(m)	l/min	0	1600	1800	2000	2200	2400	2600	2800	3000	3200
	kW	HP		l/sec	0	26,67	30	33,33	36,67	40	43,33	46,67	50	53,33
				m³/h	0	96	108	120	132	144	156	168	180	192
180 REC 160/1	9,2	12,5	24	19	18	17	16	16	15	13	12	10		
180 REC 160/2	18,5	25	49	38	36	35	33	31	30	27	24	20		
180 REC 160/3	26	35	73	57	54	52	49	47	45	40	36	30		
180 REC 160/4	37	50	97	76	72	69	66	63	59	54	48	40		
180 REC 160/5	44	60	121	95	90	86	82	79	74	67	60	50		
180 REC 160/6	55	75	146	114	108	104	99	94	89	81	72	60		
180 REC 160/7	66	90	170	133	126	121	115	110	104	94	84	70		
180 REC 160/8	75	100	194	152	144	138	131	126	119	107	96	80		
180 REC 160/9	75	100	219	171	162	156	148	141	134	121	108	90		
180 REC 160/10	92	125	243	190	180	173	164	157	149	134	120	100		
180 REC 160/11	92	125	267	209	198	190	181	173	163	148	132	110		
180 REC 160/12	110	150	291	228	216	207	197	189	178	161	144	120		
180 REC 160/13	110	150	316	247	234	225	214	204	193	175	156	130		

DIMENSIONI D'INGOMBRO E PESI - OVERALL DIMENSIONS AND WEIGHTS

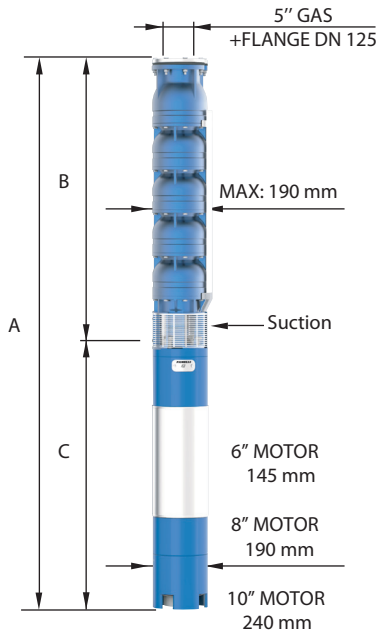

Type	A mm Tri V 400	B mm	C mm Tri	M Kg Tri	P Kg
180 REC 160/1	1303	552	751	60	24
180 REC 160/2	1693	702	991	83	33
180 REC 160/3	2033	852	1181	100	42
180 REC 160/4	2343	1002	1341	118	51
180 REC 160/5	2275	1152	1123	178	60
180 REC 160/6	2535	1302	1233	200	69
180 REC 160/7	2755	1452	1303	214	78
180 REC 160/8	2985	1602	1383	230	87
180 REC 160/9	3135	1752	1383	230	96
180 REC 160/10	3485	1902	1583	270	105
180 REC 160/11	3635	2052	1583	270	114
180 REC 160/12	3935	2202	1733	300	123
180 REC 160/13	4085	2352	1733	300	132

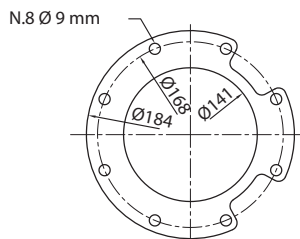

FOR COMMERCIAL TUBE
EXTERNAL DIAMETER: 139,7 mm

n% = Rendimento della pompa
n% = Rendement de la pompe
n% = Pump efficiency
n% = Rendimiento de la bomba

**Max
74%**

kW/st = Assorbimento per stadio
kW/st = Absorption par étage
kW/st = Stage absorption
kW/st = Potencia absorbida por etapa

**Max
8,6**

Tolleranza alla sabbia 50 g/m³ - Sand tolerance 50 g/m³
Tolleranze secondo UNI ISO 9906 livello 3B - Tolerances according to UNI ISO 9906 grade 3B

elevata affidabilità - high reliability

PANELLI®

8"

180 REC160

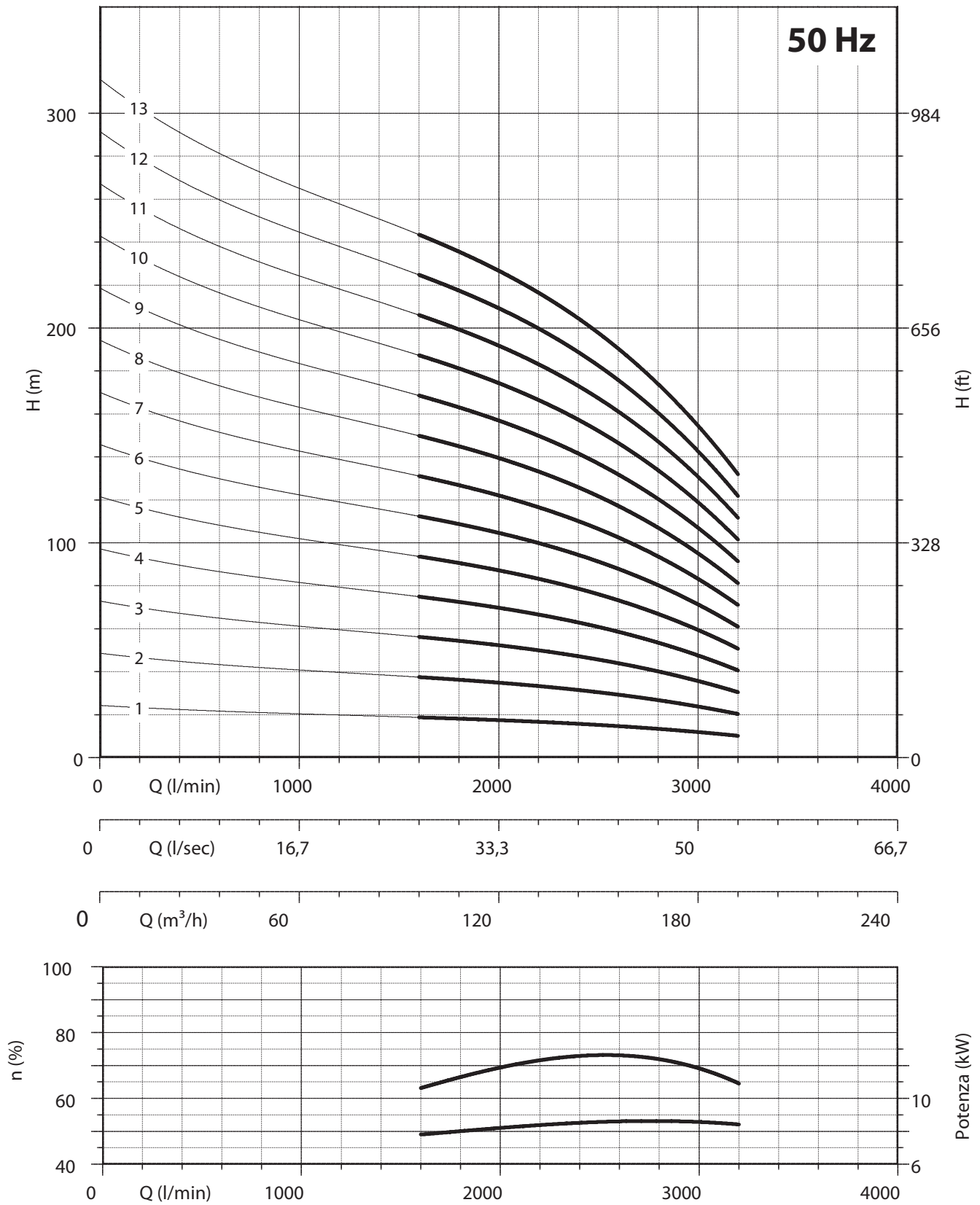

NPSH (m)	25%	50%	75%	100%
180 REC 160	4	4,5	7	13

elevata affidabilità - high reliability

10"

230 REC200



CARATTERISTICHE IDRAULICHE - HYDRAULIC PERFORMANCES

Q= Portata - Capacity - Debit **50 Hz n= 2900 min**

Tipo Type	Power		l/min l/sec m³/h	0	1800	2200	2600	3000	3400	3800
	kW	HP		0	30	36,67	43,33	50	56,67	63,33
				H(m)						
230 REC 200/1 DR 20	15	20	32	29	28	25	24	20	16	
230 REC 200/1 DR 10	18,5	25	37	33	31	29	27	22	18	
230 REC 200/1	22	30	42	37	35	32	30	25	20	
230 REC 200/2 DR 20	30	40	65	58	55	50	48	40	32	
230 REC 200/2 DR 10	37	50	73	66	62	57	54	45	36	
230 REC 200/2	44	60	83	74	70	64	60	50	40	
230 REC 200/3 DR 20	55	75	97	88	83	76	71	59	47	
230 REC 200/3 DR 10	55	75	110	99	94	86	80	67	53	
230 REC 200/3	66	90	125	111	105	96	90	75	60	
230 REC 200/4 DR 20	66	90	130	117	110	101	95	79	63	
230 REC 200/4 DR 10	75	100	146	132	125	114	107	90	71	
230 REC 200/4	75	100	166	148	140	128	120	100	80	
230 REC 200/5 DR 20	75	100	162	146	138	126	119	99	79	
230 REC 200/5 DR 10	92	125	183	165	156	143	134	112	89	
230 REC 200/5	110	150	208	185	175	160	150	125	100	
230 REC 200/6 DR 20	92	125	194	175	166	151	143	119	95	
230 REC 200/6 DR 10	110	150	220	198	187	172	161	134	107	
230 REC 200/6	129	175	250	222	210	192	180	150	120	
230 REC 200/7 DR 20	110	150	227	204	193	176	167	139	111	
230 REC 200/7 DR 10	129	175	256	231	218	200	188	157	125	
230 REC 200/7	147	200	291	259	245	224	210	175	140	
230 REC 200/8 DR 20	129	175	259	234	221	202	190	158	126	
230 REC 200/8 DR 10	147	200	293	264	250	229	214	179	142	
230 REC 200/8	165	225	333	296	280	256	240	200	160	

DIMENSIONI D'INGOMBRO E PESI - OVERALL DIMENSIONS AND WEIGHTS

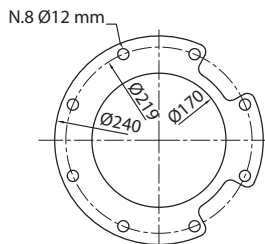
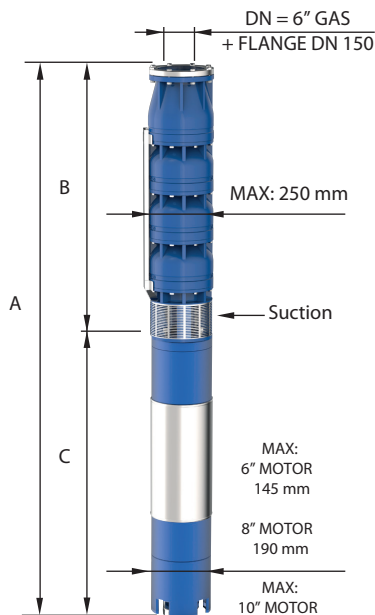

FOR COMMERCIAL TUBE
EXTERNAL DIAMETER: 168,3 mm

Type	A mm Tri V 400	B mm	C mm Tri	M Kg Tri	P Kg
230 REC 200/1 DR 20	1556	625	931	75	50
230 REC 200/1 DR 10	1616	625	991	83	50
230 REC 200/1	1696	625	1071	92	50
230 REC 200/2 DR 20	2056	805	1251	108	68
230 REC 200/2 DR 10	2146	805	1341	118	68
230 REC 200/2	1928	805	1123	178	68
230 REC 200/3 DR 20	2218	985	1233	200	87
230 REC 200/3 DR 10	2218	985	1233	200	87
230 REC 200/3	2288	985	1303	214	87
230 REC 200/4 DR 20	2468	1165	1303	214	105
230 REC 200/4 DR 10	2548	1165	1383	230	105
230 REC 200/4	2548	1165	1383	230	105
230 REC 200/5 DR 20	2728	1345	1383	230	124
230 REC 200/5 DR 10	2928	1345	1583	270	124
230 REC 200/5	3078	1345	1733	300	124
230 REC 200/6 DR 20	3108	1525	1583	270	142
230 REC 200/6 DR 10	3258	1525	1733	300	142
230 REC 200/6	3159	1525	1634	385	142
230 REC 200/7 DR 20	3438	1705	1733	300	161
230 REC 200/7 DR 10	3339	1705	1634	385	161
230 REC 200/7	3439	1705	1734	415	161
230 REC 200/8 DR 20	3519	1885	1634	385	179
230 REC 200/8 DR 10	3619	1885	1734	415	179
230 REC 200/8	3739	1885	1854	444	179

n% = Rendimento della pompa
n% = Rendement de la pompe
n% = Pump efficiency
n% = Rendimiento de la bomba

Max
75,5%

DR 10
Max 75%

DR 20
Max 74%

kW/st = Assorbimento per stadio
kW/st = Absorption par étage
kW/st = Stage absorption
kW/st = Potencia absorbida por etapa

Max
19,4

DR 10
Max 17,5

DR 20
Max 15,7

Tolleranza alla sabbia 50 g/m³ - Sand tolerance 50 g/m³

Tolleranze secondo UNI ISO 9906 livello 3B - Tolerances according to UNI ISO 9906 grade 3B

elevata affidabilità - high reliability

PANELLI®

10"
230 REC200

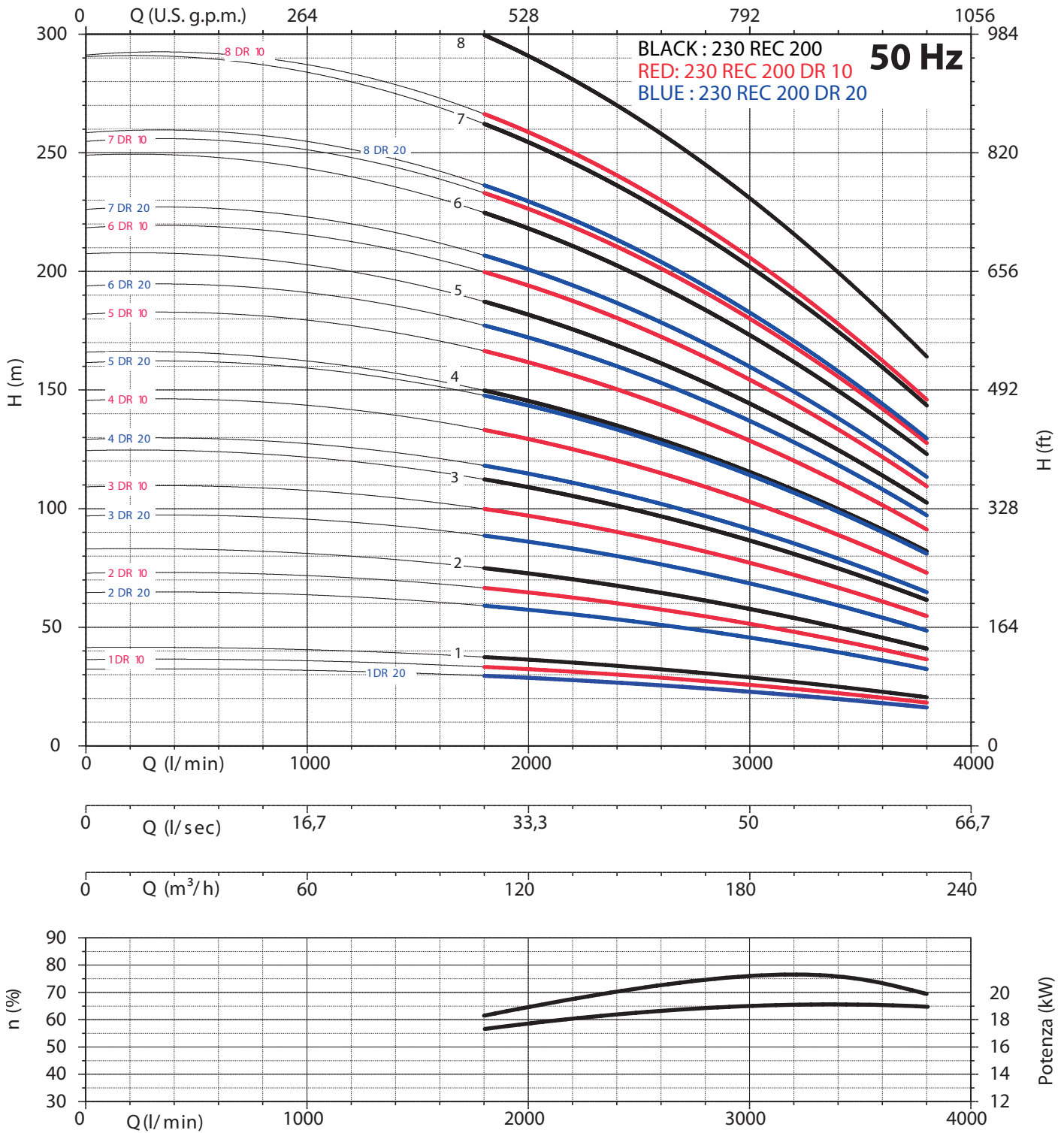

NPSH (m)	25%	50%	75%	100%
230 REC 200	3,6	5,3	8,1	14

elevata affidabilità - high reliability

10"

230 REC220



CARATTERISTICHE IDRAULICHE - HYDRAULIC PERFORMANCES

Q= Portata - Capacity - Debit **50 Hz n= 2900 min**

Tipo Type	Power		H(m)	0	2200	2600	3000	3400	3800	4200	4400	
	kW	HP		l/min	l/sec	m ³ /h	l/min	l/sec	m ³ /h	l/min	l/sec	m ³ /h
				0	36,67	43,33	50	56,67	63,33	70	73,33	
230 REC 220/1 DR 20	18,5	25	34	29	28	26	24	22	19	16		
230 REC 220/1 DR 10	22	30	38	33	31	29	27	25	21	17		
230 REC 220/1	22	30	43	37	35	33	30	28	24	22		
230 REC 220/2 DR 20	37	50	68	58	55	52	48	44	38	33		
230 REC 220/2 DR 10	44	60	77	66	62	59	54	50	43	35		
230 REC 220/2	44	60	86	74	70	66	60	56	48	44		
230 REC 220/3 DR 20	55	75	102	88	83	78	71	67	57	49		
230 REC 220/3 DR 10	66	90	115	99	94	88	80	75	64	52		
230 REC 220/3	75	100	129	111	105	99	90	84	72	66		
230 REC 220/4 DR 20	75	100	136	117	110	104	95	89	76	66		
230 REC 220/4 DR 10	92	125	154	132	125	118	107	100	86	70		
230 REC 220/4	92	125	172	148	140	132	120	112	96	88		
230 REC 220/5 DR 20	92	125	170	146	138	130	119	111	95	82		
230 REC 220/5 DR 10	110	150	192	165	156	147	134	125	107	87		
230 REC 220/5	129	175	215	185	175	165	150	140	120	110		
230 REC 220/6 DR 20	110	150	204	175	166	156	143	133	114	98		
230 REC 220/6 DR 10	129	175	230	198	187	176	161	150	128	104		
230 REC 220/6	147	200	258	222	210	198	180	168	144	132		
230 REC 220/7 DR 20	129	175	238	204	193	182	167	155	133	115		
230 REC 220/7 DR 10	147	200	269	231	218	206	188	175	150	122		
230 REC 220/7	165	225	301	259	245	231	210	196	168	154		

DIMENSIONI D'INGOMBRO E PESI - OVERALL DIMENSIONS AND WEIGHTS

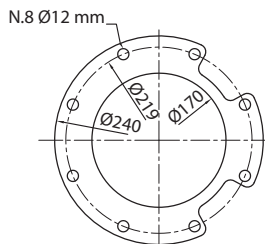
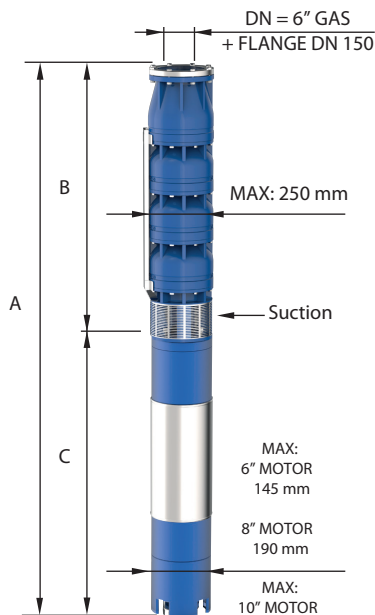

FOR COMMERCIAL TUBE
EXTERNAL DIAMETER: 168,3 mm

Type	A mm Tri V 400	B mm	C mm Tri	M Kg Tri	P Kg
230 REC 220/1 DR 20	1616	625	991	83	50
230 REC 220/1 DR 10	1696	625	1071	92	50
230 REC 220/1	1696	625	1071	92	50
230 REC 220/2 DR 20	2146	805	1341	118	68
230 REC 220/2 DR 10	1928	805	1123	178	68
230 REC 220/2	1928	805	1123	178	68
230 REC 220/3 DR 20	2218	985	1233	200	87
230 REC 220/3 DR 10	2288	985	1303	214	87
230 REC 220/3	2368	985	1383	230	87
230 REC 220/4 DR 20	2548	1165	1383	230	105
230 REC 220/4 DR 10	2748	1165	1583	270	105
230 REC 220/4	2748	1165	1583	270	105
230 REC 220/5 DR 20	2928	1345	1583	270	124
230 REC 220/5 DR 10	3078	1345	1733	300	124
230 REC 220/5	2979	1345	1634	385	124
230 REC 220/6 DR 20	3258	1525	1733	300	142
230 REC 220/6 DR 10	3159	1525	1634	385	142
230 REC 220/6	3259	1525	1734	415	142
230 REC 220/7 DR 20	3339	1705	1634	385	161
230 REC 220/7 DR 10	3439	1705	1734	415	161
230 REC 220/7	3559	1705	1854	444	161

n% = Rendimento della pompa
n% = Rendement de la pompe
n% = Pump efficiency
n% = Rendimiento de la bomba

Max
76,5%

DR 10
Max 76%

DR 20
Max 75,5%

kW/st = Assorbimento per stadio
kW/st = Absorption par étage
kW/st = Stage absorption
kW/st = Potencia absorbida por etapa

Max
23

DR 10
Max 20,5

DR 20
Max 18,3

Tolleranza alla sabbia 50 g/m³ - Sand tolerance 50 g/m³

Tolleranze secondo UNI ISO 9906 livello 3B - Tolerances according to UNI ISO 9906 grade 3B

elevata affidabilità - high reliability

PANELLI®

10"
230 REC220

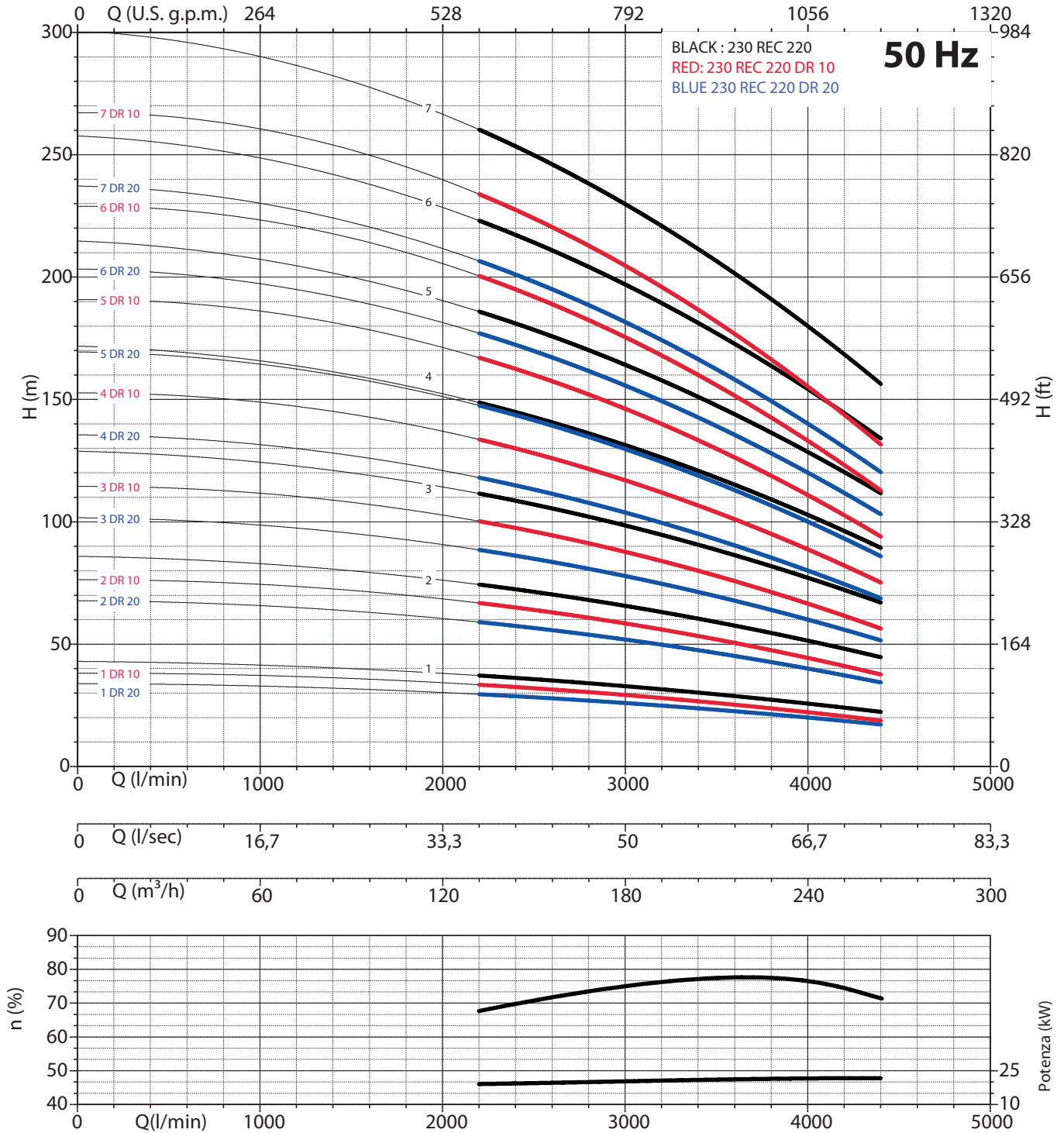

NPSH (m)	25%	50%	75%	100%
230 REC 220	3,7	5,4	8,3	14,2

elevata affidabilità - high reliability

10"

230 REC240



CARATTERISTICHE IDRAULICHE - HYDRAULIC PERFORMANCES

Q= Portata - Capacity - Debit **50 Hz n= 2900 min**

Tipo Type	Power		l/min	0	2400	2800	3200	3600	4000	4400	4800	5000
	kW	HP										
230 REC 240/1 DR 20	22	30	l/sec	0	40	46,67	53,33	60	66,67	73,33	80	83,33
230 REC 240/1 DR 10	26	35	m³/h	0	144	168	192	216	240	264	288	300
230 REC 240/1	26	35	H(m)	34	28	27	26	25	22	21	18	17
230 REC 240/2 DR 20	44	60		38	32	30	29	28	25	23	20	20
230 REC 240/2 DR 10	55	75		43	36	34	33	31	28	26	23	22
230 REC 240/2	55	75		68	57	54	52	49	44	41	36	35
230 REC 240/3 DR 20	66	90		77	64	61	59	55	50	46	41	39
230 REC 240/3 DR 10	75	100		86	72	68	66	62	56	52	46	44
230 REC 240/3	92	125		102	85	81	79	74	67	62	55	52
230 REC 240/4 DR 20	92	125		115	96	91	88	83	75	70	61	59
230 REC 240/4 DR 10	92	125		129	108	102	99	93	84	78	69	66
230 REC 240/4	110	150		136	114	108	105	98	89	82	73	70
230 REC 240/5 DR 20	110	150		154	128	122	118	110	100	93	82	78
230 REC 240/5 DR 10	129	175		172	144	136	132	124	112	104	92	88
230 REC 240/5	129	175		170	142	135	131	123	111	103	91	87
230 REC 240/6 DR 20	129	175		192	160	152	147	138	125	116	102	98
230 REC 240/6 DR 10	147	200		215	180	170	165	155	140	130	115	110
230 REC 240/6	165	225		204	170	162	157	148	133	124	109	104
230 REC 240/7 DR 20	165	225		230	192	182	176	166	150	139	122	118
230 REC 240/7 DR 10	165	225		258	216	204	198	186	168	156	138	132
230 REC 240/7	165	225		238	199	189	183	172	155	144	127	122
230 REC 240/7 DR 10	165	225		269	224	213	206	193	175	162	143	137

DIMENSIONI D'INGOMBRO E PESI - OVERALL DIMENSIONS AND WEIGHTS

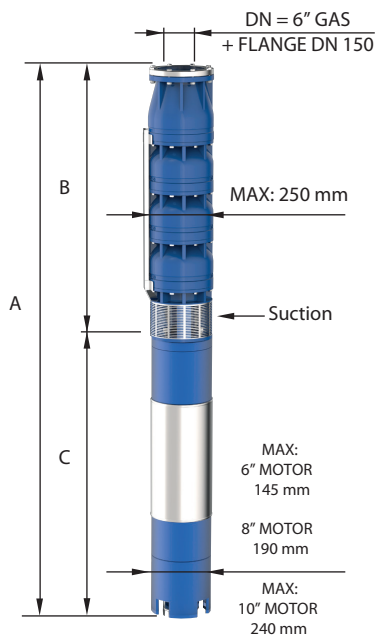

Type	A mm Tri V 400	B mm	C mm Tri	M Kg Tri	P Kg
230 REC 240/1 DR 20	1696	625	1071	92	50
230 REC 240/1 DR 10	1806	625	1181	100	50
230 REC 240/1	1806	625	1181	100	50
230 REC 240/2 DR 20	1928	805	1123	178	68
230 REC 240/2 DR 10	2038	805	1233	200	68
230 REC 240/2	2038	805	1233	200	68
230 REC 240/3 DR 20	2288	985	1303	214	87
230 REC 240/3 DR 10	2368	985	1383	230	87
230 REC 240/3	2568	985	1583	270	87
230 REC 240/4 DR 20	2748	1165	1583	270	105
230 REC 240/4 DR 10	2748	1165	1583	270	105
230 REC 240/4	2898	1165	1733	300	105
230 REC 240/5 DR 20	3078	1345	1733	300	124
230 REC 240/5 DR 10	2979	1345	1634	385	124
230 REC 240/5	2979	1345	1634	385	124
230 REC 240/6 DR 20	3159	1525	1634	385	142
230 REC 240/6 DR 10	3259	1525	1734	415	142
230 REC 240/6	3379	1525	1854	444	142
230 REC 240/7 DR 20	3559	1705	1854	444	161
230 REC 240/7 DR 10	3559	1705	1854	444	161

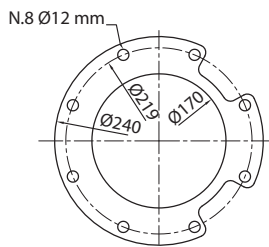

FOR COMMERCIAL TUBE
EXTERNAL DIAMETER: 168,3 mm

n% = Rendimento della pompa
n% = Rendement de la pompe
n% = Pump efficiency
n% = Rendimiento de la bomba

Max 76,5%

DR 10 Max 76%

DR 20 Max 75,5%

kW/st = Assorbimento per stadio
kW/st = Absorption par étage
kW/st = Stage absorption
kW/st = Potencia absorbida por etapa

Max 26,3

DR 10 Max 23,5

DR 20 Max 21,9

Tolleranza alla sabbia 50 g/m³ - Sand tolerance 50 g/m³

Tolleranze secondo UNI ISO 9906 livello 3B - Tolerances according to UNI ISO 9906 grade 3B

elevata affidabilità - high reliability

PANELLI®

10"
230 REC240

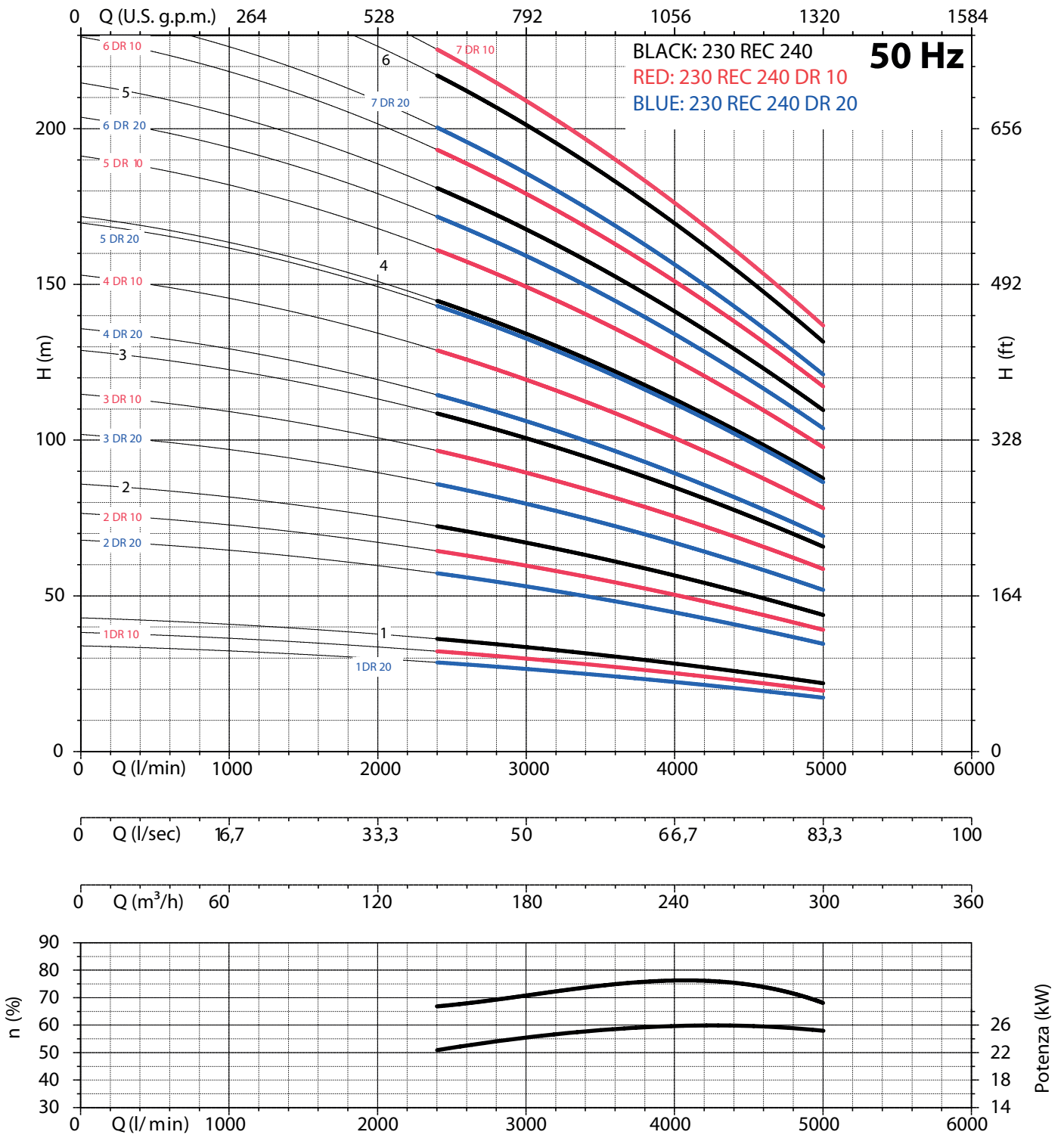

NPSH (m)	25%	50%	75%	100%
230 REC 240	3,9	5,5	8,5	14,4

6" - 8" - 10" REC - 33



italian excellence since 1906

10" 230 REC | **50Hz**

POMPA SOMMERSA SEMIASSIALE - GHISA
SEMIAXIAL SUBMERSIBLE PUMP - CAST IRON

POMPA 10" ACCOPPIATA A MOTORE 6"
10" PUMP COUPLING WITH 6" MOTORS
CONNECTION FLANGE

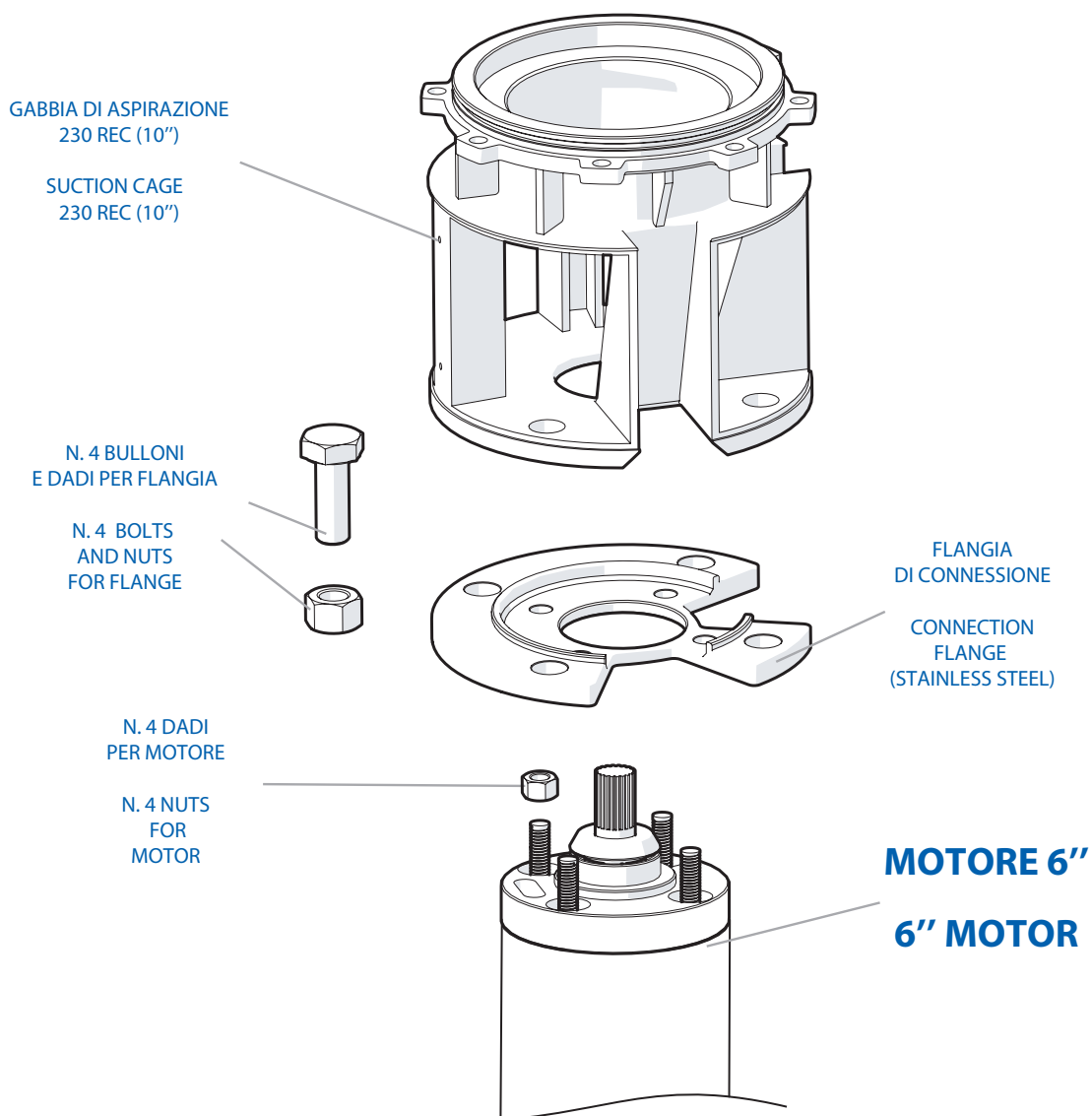



italian excellence since 1906

6" 8" 10" 140 REC
180 REC | **50Hz**
230 REC

POMPA SOMMERSA SEMIASSIALE - GHISA
SEMIAXIAL SUBMERSIBLE PUMP - CAST IRON

RICAMBI
TABELLE MATERIALI

SPARE PARTS
MATERIAL CHARTS

6" 8" 10"

140 - 180 - 230 REC

PANELLI®

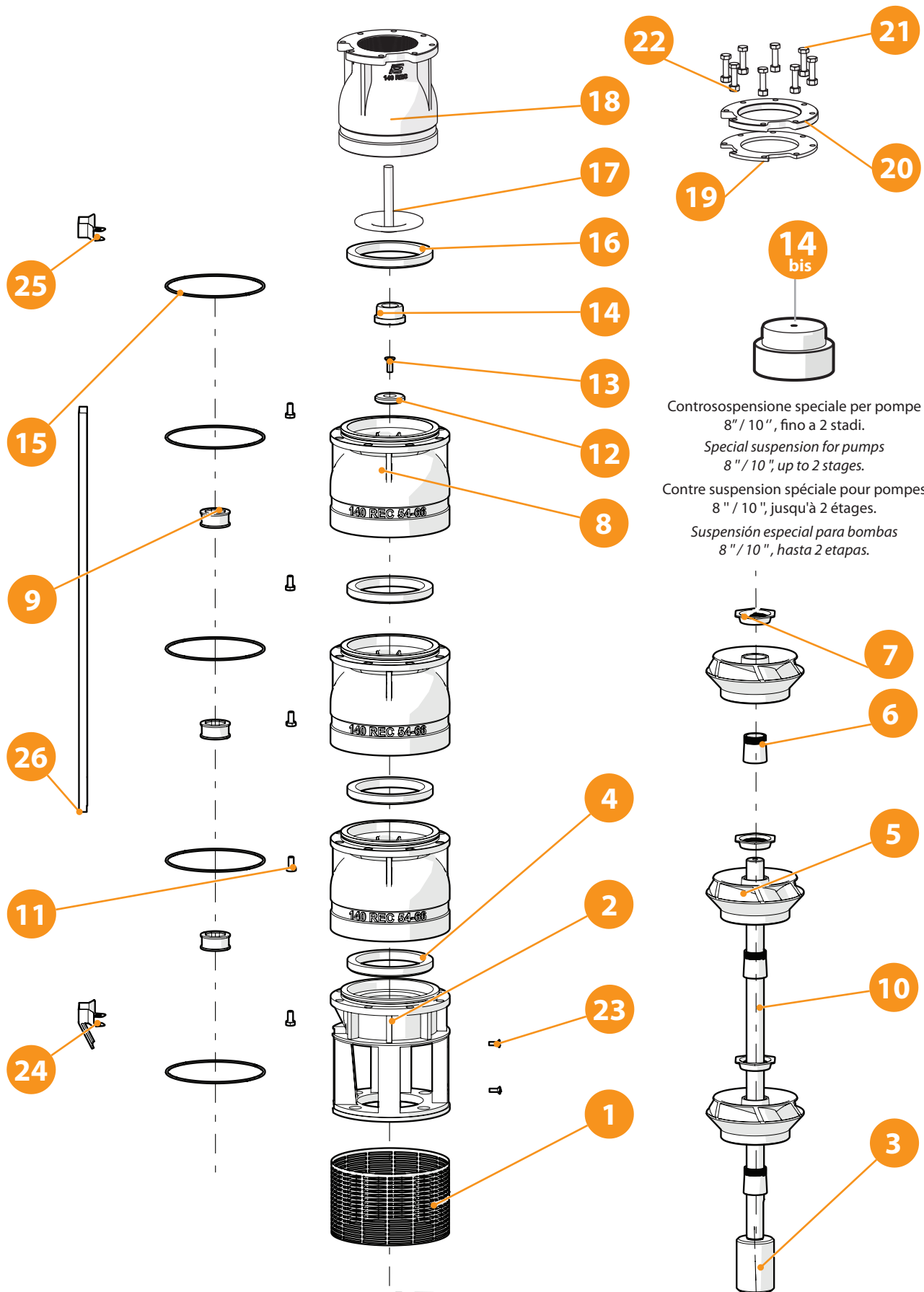

Controsospensione speciale per pompe 8" / 10", fino a 2 stadi.

Special suspension for pumps 8" / 10", up to 2 stages.

Contre suspension spéciale pour pompes 8" / 10", jusqu'à 2 étages.

Suspensión especial para bombas 8" / 10", hasta 2 etapas.

140 - 180 - 230 REC

N. CODE	DESCRIZIONE (italiano)	MATERIALE (italiano)	DESCRIZIONE (english)	MATERIAL (english)
1	SUCCHERUOLA	ACCIAIO INOX AISI 304	SUCTION STRAINER	AISI 304
2	GABBIA DI ASPIRAZIONE	GHISA	SUCTION CAGE	CAST IRON
3	GIUNTO	ACCIAIO INOX AISI 304	JOINT	AISI 304
4	ANELLO USURA	GOMMA	USURY RING	NBR
5	GIRANTE	GHISA	IMPELLER	CAST IRON
6	CONO	ACCIAIO INOX AISI 304	CONE	AISI 304
7	GHIERA	ACCIAIO INOX AISI 304	HEXAGONAL RING	AISI 304
8	DIFFUSORE	GHISA	DIFFUSEUR	CAST IRON
9	BRONZINA	GOMMA	BEARING BUSH	NBR
10	ALBERO POMPA	ACCIAIO INOX AISI 304	PUMP SHAFT	AISI 304
11	N. 8 VITI PER DIFFUSORE	ACCIAIO INOX AISI 304	N.8 SCREW FOR DIFFUSEUR	AISI 304
12	DISCO ACCIAIO	ACCIAIO INOX AISI 304	RING	AISI 304
13	VITE DISCO ACCIAIO	ACCIAIO INOX AISI 304	SCREW FOR DISK	AISI 304
14	CONTROSOSPENSIONE	PTFE + 25 CARBONE	COUNTERTHRUST	PTFE + 25 CARBON
15	O-RING	GOMMA	O-RING	NBR
16	GUARNIZIONE FARFALLA	GOMMA	GASKET VALVE	NBR
17	FARFALLA	ACCIAIO INOX AISI 304	CAP VALVE	AISI 304
18	CORPO VALVOLA	GHISA	BODY VALVE	CAST IRON
19	UARNIZIONE CONTROFLANGIA	GOMMA	SEAL COUNTERFLANGE	NBR
20	CONTROFLANGIA	FERRO	COUNTERFLANGE	IRON
21	N. 8 VITI PER CONTROFLANGIA	ACCIAIO INOX AISI 304	N. 8 SCREWS FOR COUNTERFLANGE	AISI 304
22	N. 8 DADI PER CONTROFLANGIA	ACCIAIO INOX AISI 304	N.8 NUT FOR COUNTERFLANGE	AISI 304
23	N. 2 VITI PER SUCCHERUOLA	ACCIAIO INOX AISI 304	N. 2 SCREWS FOR SUCTION STRAINER	AISI 304
24	STAFFETTA INFERIORE	ACCIAIO INOX AISI 304	LOWER FLANGE	AISI 304
25	STAFFETTA SUPERIORE	ACCIAIO INOX AISI 304	UPPER FLANGE	AISI 304
26	COPRICAPO	ACCIAIO INOX AISI 304	COVER CABLE	AISI 304

N. CODE	DESCRIPTION (Français)	MATÉRIEL (Français)	DESCRIPCIÓN (español)	MATERIAL (español)
1	CREPINE	ACIER INOXYDABLE AISI 304	REJILLA	ACERO INOXYDABLE AISI 304
2	CAGE D'ASPIRATION	FONTE	CUERPO DE ASPIRACION	HIERRO FUNDIDO
3	JOINT	ACIER INOXYDABLE AISI 304	ACOPLAMIENTO	ACERO INOXYDABLE AISI 304
4	BAGUE D'USURE	CAOUTCHOUC	ANILLO DE DESGASTE	GOMA
5	ROUE	FONTE	IMPULSOR	HIERRO FUNDIDO
6	CONE	ACIER INOXYDABLE AISI 304	CONO	ACERO INOXYDABLE AISI 304
7	BAGUE	ACIER INOXYDABLE AISI 304	ANILLO HEXAGONAL	ACERO INOXYDABLE AISI 304
8	DIFFUSEUR	FONTE	DIFUSOR	HIERRO FUNDIDO
9	COUSSINET	CAOUTCHOUC	COJINETE	GOMA
10	ABRE POMPE	ACIER INOXYDABLE AISI 304	EJE DE BOMBA	ACERO INOXYDABLE AISI 304
11	N. 8 VIS POUR DIFFUSEUR	ACIER INOXYDABLE AISI 304	N. 8 TORNILLOS DIFUSOR	ACERO INOXYDABLE AISI 304
12	RING	ACIER INOXYDABLE AISI 304	ANILLO EN ACERO	ACERO INOXYDABLE AISI 304
13	VIS RING	ACIER INOXYDABLE AISI 304	TORNILLO POR ANILLO EN ACERO	ACERO INOXYDABLE AISI 304
14	CONTRESUSPENSION	PTFE + 25% GRAPHITE	CONTRA-SUSPENSION	PTFE + 25% GRAPHITE
15	O-RING	CAOUTCHOUC	ANILLO TORICO	GOMA
16	GASKET VALVE	CAOUTCHOUC	JUNTA DE VALVULA	GOMA
17	PLAT	ACIER INOXYDABLE AISI 304	VALVULA	ACERO INOXYDABLE AISI 304
18	CORPS DE VALVE	FONTE	CUERPO DE IMPULSION	HIERRO FUNDIDO
19	JOINT ETANCHEITE CONTREBRIDE	CAOUTCHOUC	JUNTA CONTRE-BRIDA	GOMA
20	CONTREBRIDE	FER	CONTRE-BRIDA	HIERRO
21	N. 8 VIS POUR CONTREBRIDE	ACIER INOXYDABLE AISI 304	N. 8 TORNILLOS CONTRE-BRIDA	ACERO INOXYDABLE AISI 304
22	N. 8 ECROU POUR CONTREBRIDE	ACIER INOXYDABLE AISI 304	N. 8 TUERCAS CONTRE-BRIDA	ACERO INOXYDABLE AISI 304
23	N. 2 VIS POUR CREPINE	ACIER INOXYDABLE AISI 304	N. 2 TORNILLOS REJILLA	ACERO INOXYDABLE AISI 304
24	BRIDE INFERIEURE	ACIER INOXYDABLE AISI 304	GRAPA INFERIOR	ACERO INOXYDABLE AISI 304
25	BRIDE SUPERIEURE	ACIER INOXYDABLE AISI 304	GRAPA SUPERIOR	ACERO INOXYDABLE AISI 304
26	PROTECTOR CABLE	ACIER INOXYDABLE AISI 304	PARACABLE	ACERO INOXYDABLE AISI 304

14 BIS

CONTROSOSPENSIONE SPECIALE PER POMPE 8" / 10"; FINO A 2 STADI

SPECIAL SUSPENSION FOR PUMPS 8" / 10"; UP TO 2 STAGES

CONTRE SUSPENSION SPÉCIALE POUR POMPES 8" / 10"; JUSQU'À 2 ÉTAGES

SUSPENSIÓN ESPECIAL PARA BOMBAS 8" / 10"; HASTA 2 ETAPAS

PTFE + 25 CARBONE

PTFE + 25 CARBON

PTFE + 25% GRAPHITE

PTFE + 25% GRAPHITE

elevata affidabilità - high reliability

6" 8" 10"

140 - 180 - 230 REC

PANELLI®

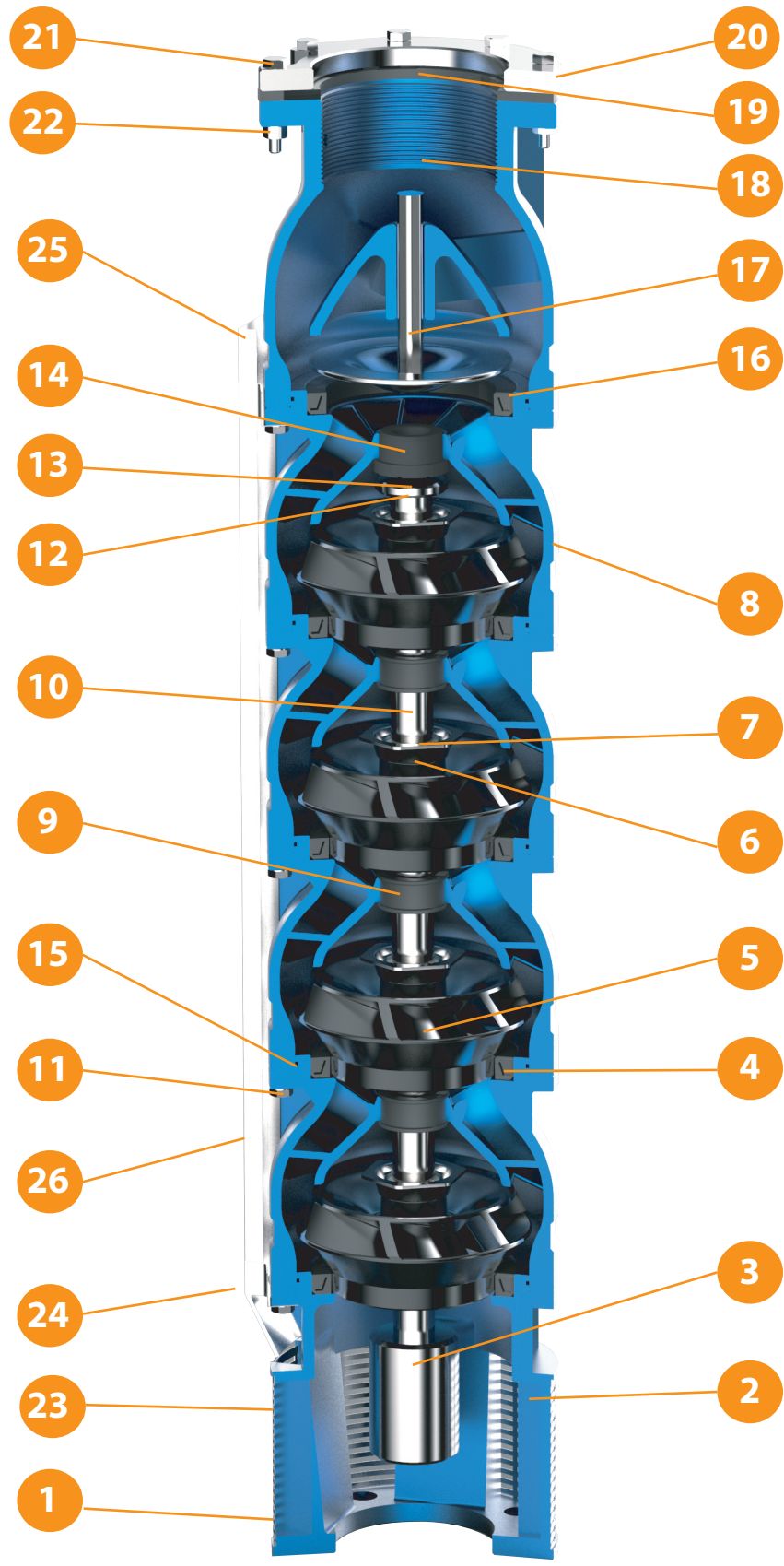

Controsospensione speciale per pompe
8" / 10", fino a 2 stadi.
*Special suspension for pumps
8" / 10", up to 2 stages.*
Contre suspension spéciale pour pompes
8" / 10", jusqu'à 2 étages.
*Suspensión especial para bombas
8" / 10", hasta 2 etapas.*

140 - 180 - 230 REC

N. CODE	DESCRIZIONE (italiano)	MATERIALE (italiano)	DESCRIZIONE (english)	MATERIAL (english)
1	SUCCHERUOLA	ACCIAIO INOX AISI 304	SUCTION STRAINER	AISI 304
2	GABBIA DI ASPIRAZIONE	GHISA	SUCTION CAGE	CAST IRON
3	GIUNTO	ACCIAIO INOX AISI 304	JOINT	AISI 304
4	ANELLO USURA	GOMMA	USURY RING	NBR
5	GIRANTE	GHISA	IMPELLER	CAST IRON
6	CONO	ACCIAIO INOX AISI 304	CONE	AISI 304
7	GHIERA	ACCIAIO INOX AISI 304	HEXAGONAL RING	AISI 304
8	DIFFUSORE	GHISA	DIFFUSEUR	CAST IRON
9	BRONZINA	GOMMA	BEARING BUSH	NBR
10	ALBERO POMPA	ACCIAIO INOX AISI 304	PUMP SHAFT	AISI 304
11	N. 8 VITI PER DIFFUSORE	ACCIAIO INOX AISI 304	N.8 SCREW FOR DIFFUSEUR	AISI 304
12	DISCO ACCIAIO	ACCIAIO INOX AISI 304	RING	AISI 304
13	VITE DISCO ACCIAIO	ACCIAIO INOX AISI 304	SCREW FOR DISK	AISI 304
14	CONTROSOSPENSIONE	PTFE + 25 CARBONE	COUNTERTHRUST	PTFE + 25 CARBON
15	O-RING	GOMMA	O-RING	NBR
16	GUARNIZIONE FARFALLA	GOMMA	GASKET VALVE	NBR
17	FARFALLA	ACCIAIO INOX AISI 304	CAP VALVE	AISI 304
18	CORPO VALVOLA	GHISA	BODY VALVE	CAST IRON
19	UARNIZIONE CONTROFLANGIA	GOMMA	SEAL COUNTERFLANGE	NBR
20	CONTROFLANGIA	FERRO	COUNTERFLANGE	IRON
21	N. 8 VITI PER CONTROFLANGIA	ACCIAIO INOX AISI 304	N. 8 SCREWS FOR COUNTERFLANGE	AISI 304
22	N. 8 DADI PER CONTROFLANGIA	ACCIAIO INOX AISI 304	N.8 NUT FOR COUNTERFLANGE	AISI 304
23	N. 2 VITI PER SUCCHERUOLA	ACCIAIO INOX AISI 304	N. 2 SCREWS FOR SUCTION STRAINER	AISI 304
24	STAFFETTA INFERIORE	ACCIAIO INOX AISI 304	LOWER FLANGE	AISI 304
25	STAFFETTA SUPERIORE	ACCIAIO INOX AISI 304	UPPER FLANGE	AISI 304
26	COPRICAPO	ACCIAIO INOX AISI 304	COVER CABLE	AISI 304

N. CODE	DESCRIPTION (Français)	MATÉRIEL (Français)	DESCRIPCIÓN (español)	MATERIAL (español)
1	CREPINE	ACIER INOXYDABLE AISI 304	REJILLA	ACERO INOXYDABLE AISI 304
2	CAGE D'ASPIRATION	FONTE	CUERPO DE ASPIRACION	HIERRO FUNDIDO
3	JOINT	ACIER INOXYDABLE AISI 304	ACOPLAMIENTO	ACERO INOXYDABLE AISI 304
4	BAGUE D'USURE	CAOUTCHOUC	ANILLO DE DESGASTE	GOMA
5	ROUE	FONTE	IMPULSOR	HIERRO FUNDIDO
6	CONO	ACIER INOXYDABLE AISI 304	CONO	ACERO INOXYDABLE AISI 304
7	BAGUE	ACIER INOXYDABLE AISI 304	ANILLO HEXAGONAL	ACERO INOXYDABLE AISI 304
8	DIFFUSEUR	FONTE	DIFUSOR	HIERRO FUNDIDO
9	COUSSINET	CAOUTCHOUC	COJINETE	GOMA
10	ABRE POMPE	ACIER INOXYDABLE AISI 304	EJE DE BOMBA	ACERO INOXYDABLE AISI 304
11	N. 8 VIS POUR DIFFUSEUR	ACIER INOXYDABLE AISI 304	N. 8 TORNILLOS DIFUSOR	ACERO INOXYDABLE AISI 304
12	RING	ACIER INOXYDABLE AISI 304	ANILLO EN ACERO	ACERO INOXYDABLE AISI 304
13	VIS RING	ACIER INOXYDABLE AISI 304	TORNILLO POR ANILLO EN ACERO	ACERO INOXYDABLE AISI 304
14	CONTRESUSPENSION	PTFE + 25% GRAPHITE	CONTRA-SUSPENSION	PTFE + 25% GRAPHITE
15	O-RING	CAOUTCHOUC	ANILLO TORICO	GOMA
16	GASKET VALVE	CAOUTCHOUC	JUNTA DE VALVULA	GOMA
17	PLAT	ACIER INOXYDABLE AISI 304	VALVULA	ACERO INOXYDABLE AISI 304
18	CORPS DE VALVE	FONTE	CUERPO DE IMPULSION	HIERRO FUNDIDO
19	JOINT ETANCHEITE CONTREBRIDE	CAOUTCHOUC	JUNTA CONTRE-BRIDA	GOMA
20	CONTREBRIDE	FER	CONTRE-BRIDA	HIERRO
21	N. 8 VIS POUR CONTREBRIDE	ACIER INOXYDABLE AISI 304	N. 8 TORNILLOS CONTRE-BRIDA	ACERO INOXYDABLE AISI 304
22	N. 8 ECROU POUR CONTREBRIDE	ACIER INOXYDABLE AISI 304	N. 8 TUERCAS CONTRE-BRIDA	ACERO INOXYDABLE AISI 304
23	N. 2 VIS POUR CREPINE	ACIER INOXYDABLE AISI 304	N. 2 TORNILLOS REJILLA	ACERO INOXYDABLE AISI 304
24	BRIDE INFERIEURE	ACIER INOXYDABLE AISI 304	GRAPA INFERIOR	ACERO INOXYDABLE AISI 304
25	BRIDE SUPERIEURE	ACIER INOXYDABLE AISI 304	GRAPA SUPERIOR	ACERO INOXYDABLE AISI 304
26	PROTECTOR CABLE	ACIER INOXYDABLE AISI 304	PARACABLE	ACERO INOXYDABLE AISI 304

14 BIS

CONTROSOSPENSIONE SPECIALE PER POMPE 8" / 10"; FINO A 2 STADI

SPECIAL SUSPENSION FOR PUMPS 8" / 10"; UP TO 2 STAGES

CONTRE SUSPENSION SPÉCIALE POUR POMPES 8" / 10"; JUSQU'À 2 ÉTAGES

SUSPENSIÓN ESPECIAL PARA BOMBAS 8" / 10"; HASTA 2 ETAPAS

PTFE + 25 CARBONE

PTFE + 25 CARBON

PTFE + 25% GRAPHITE

PTFE + 25% GRAPHITE

PANELLI®

italian excellence since 1906

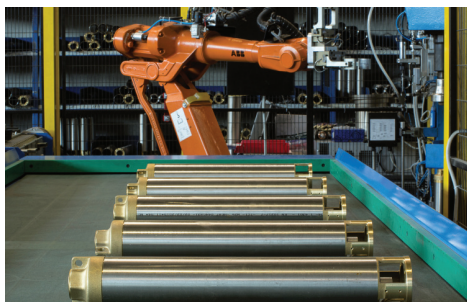
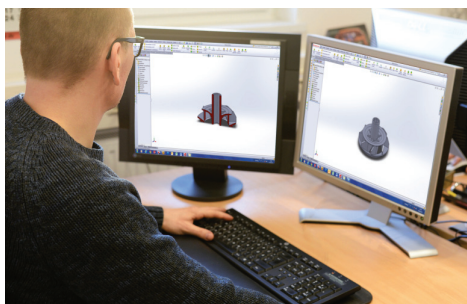

Panelli s.r.l.

Sede legale: 37047 San Bonifacio (VR) ITALY - Via E. Fermi, 7

Unità produttiva: 15122 (Alessandria) ITALY

Via Rana , 63/65 – Z.I D5 - Spinetta Marengo

Phone : + 39 0131 619506 - Fax : + 39 0131 619017

Email : info@panellipumps.it - www.panellipumps.it

Società soggetta a direzione e coordinamento di

PEDROLLO GROUP s.r.l.



6" - 8" - 10" REC - 40