



Comercialización
de equipos y accesorios
para el movimiento de fluidos.

Equipos
para estaciones
de servicios



DISPENSADORES PARA GLP

PRODUCTO ITALIANO



- > **Medidor volumétrico:** 4 pistones.
- > **Protocolo de comunicación:** Gilbarco, Dart y Modbus
- > **Temperatura de trabajo:** - 25C hasta + 55C
- > **Cabezal programable:** Litros / Galones
- > **Presión máxima de trabajo:** 18 bar
- > **Certificación:** ATEX: EX II 2G IIA T3



Modelo EDP 6000

2 mangueras

Modelo EDP 4M COMPACTO

4 mangueras

Modelo BP 6000

2 mangueras

SISTEMA DE TELEMEDICIÓN

PRODUCTO ALEMAN



Medición automática del nivel de tanques para el mejor control del nivel posible

- > Medición del nivel de los tanques en tiempo real
- > Control logístico del combustible
- > Precisión de lectura < 1%
- > Detección temprana de fugas en tanques y tuberías
- > Prevención e identificación del robo de combustibles
- > Certificación ATEX : II 1 G IECEx



Visy Command Gui

Cantidad de conexiones de sensores 2,4 u 8

Visy View Touch

Visualización permanente del tanque en las EE.SS

Sondas Visy Stick

Equipo robusto de Acero INOX de alto grado.

ELECTROBOMBAS PARA GLP

PRODUCTO ITALIANO



pompetravaini

- > Autocebante
- > Bombas de 5,7 y 8 etapas
- > Succión hasta 8m
- > Caudal máximo 35 m³/h
- > Super silenciosa
- > Motor a prueba de explosión de 7.5 HP / 10 HP / 15 HP en baja
- > Presión máxima 35 bar
- > Certificación Atex /CE/ UL

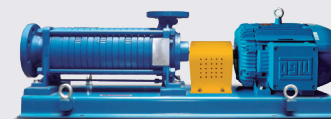
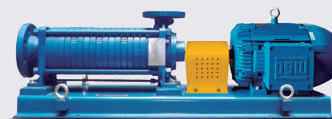
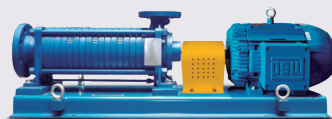

Modelo TBA 317

De 7 etapas
Motor de 7.5 HP / 10HP

Modelo TBA 405

De 5 etapas
Motor de 10 HP / 15HP

Modelo TBA 318

De 8 etapas
Motor de 7.5 HP / 10HP

PARTES DE LA BOMBA

PRODUCTO ITALIANO



pompetravaini



Sellos mecánico



Impulsores



Empaquetaduras



Eje

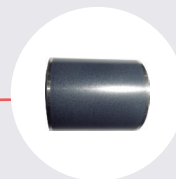

Camisa de eje

Modelo **TBA**

PISTOLAS PARA LÍQUIDOS Y GLP

HECHO EN ALEMANIA



ELAFLEX 



> Accesorios en general:

- Pistolas
- Mangueras
- Válvulas

> Accesorios para GLP y combustible líquido.

> Alto rendimiento

> Conexiones seguras, fabricado bajo altos estándares de calidad.

> Alto contenido de ingeniería y tecnología que resaltan en una larga vida.



Modelo ZVA2

Pistola Para Líquidos



Modelo ZVG 2

Pistola Para GLP

PARTES DE LA PISTOLA PARA LÍQUIDO

HECHO EN ALEMANIA



KIT COMPLETO DE MANGUERA GLP

HECHO EN ALEMANIA



Boquilla de
GLP ZVG 2



Manguera
de autogas
GLP 16

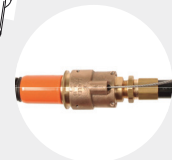

Válvula
Pull away
ARK 19

Pistola para GLP
Modelo ZVG 2

REPUESTOS DE PISTOLAS PARA GLP

HECHO EN ALEMANIA

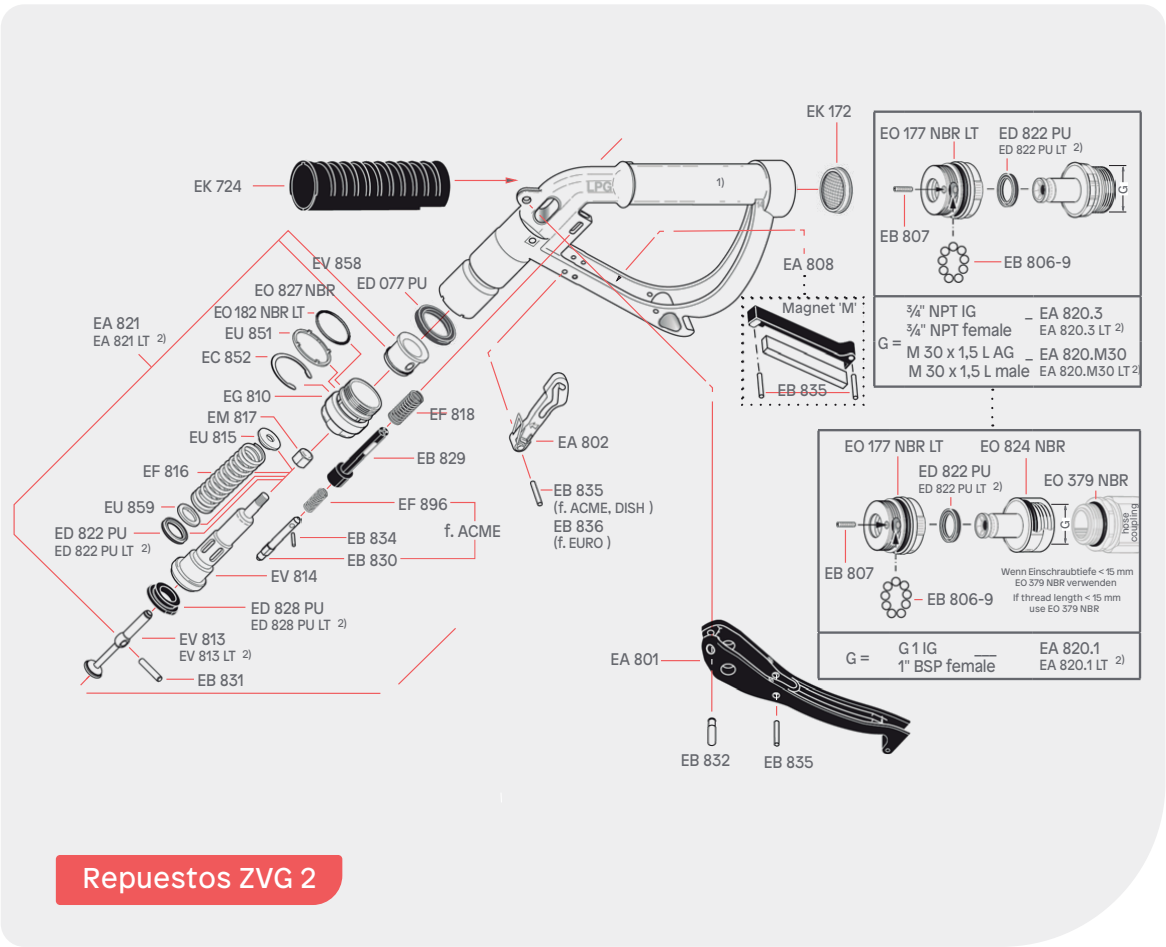

EO 177 NBR LT	ED 822 PU ED 822 PU LT 2)
EB 807	
EB 806-9	
3/4" NPT IG	EA 820.3
3/4" NPT female	EA 820.3 LT 2)
M 30 x 1,5 L AG	EA 820.M30
M 30 x 1,5 L male	EA 820.M50 LT 2)

G =

EO 177 NBR LT	EO 824 NBR
ED 822 PU ED 822 PU LT 2)	EO 379 NBR
EB 807	
EB 806-9	
Wenn Einschraubtiefe < 15 mm EO 379 NBR verwenden if thread length < 15 mm use EO 379 NBR	
G =	G 1 IG
	1" BSP female
	EA 820.1
	EA 820.1 LT 2)

Repuestos ZVG 2

Imágenes referenciales.

EQUIPOS PARA TRASIEGO DE COMBUSTIBLES

Equipos para trasiego de combustibles industrial, agrícola y minero

> Equipos en 12V, 24V y 220V > Diesel, Gasolina, Refrigerantes y urea > Mecánicos y Digitales

SURTIDORES

PIUSI



Service K44



Service FM



CUBE 70



EX50

CUENTA LITROS

PIUSI



K700

Mecánico



K33

Mecánico



K600

Digital



K24

Digital

PISTOLAS

PIUSI



PARA ALTO CAUDAL



A60 / A80 / A100

Automático



SELF 2000/3000

Manual



NOZZLE 120

Para alto caudal





ESCANEA EL CÓDIGO QR
para ingresar a nuestra web

 936 151 622

www.grupobonnett.com

Conoce mas de nuestros
productos GLP en

 **BonnettGLP**